



Your Solutions Partner

Installation and Operation Manual

READY FLEX™

HOT HOLDING CABINET

MODELS

RFHU-21F

RFHU-31F

RFHU-41F

RFHU-51F

RFHU-22F

RFHU-23F

RFHU-52F

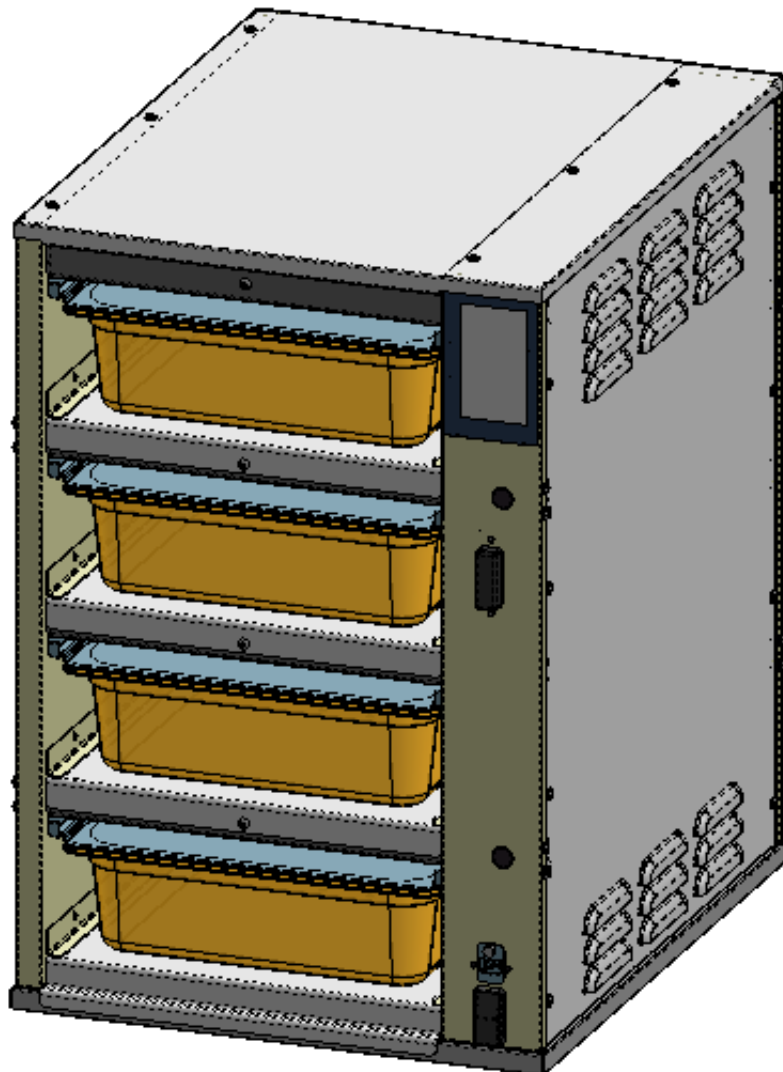

CAUTION: Please read this manual completely before attempting to install, operate or service this equipment



WARNING for CA residents: go to www.dukemfg.com/prop65 for prop 65 warning

*This manual is Copyright © 2023 Duke Manufacturing Co. All rights reserved.
Reproduction without written permission is prohibited. Duke is a registered
trademark of the Duke Manufacturing Co.*

U.S. and Foreign Patents Pending

**P/N 229431
REV C 09/29/2023**



TABLE OF CONTENTS

Manufacturer's Introduction	3
Important Safety Instructions	4-5
Installation	6
Stacking Units	7
RFHU Operating Instructions	8
Overview	8
Preheating	10
Faults.....	10
Units With Timer Bars.....	11
RFHU Daypart Menu	12
Settings	13
Menu.....	13
Temp Mode.....	13
PHU Configurator	13
Language	14
RFHU Recipe Editor.....	14
Help.....	15
About.....	15
Tools Menu.....	15
Network	15
PHU Volume	18
Admin.....	18
Manager	18
Access Menu	18
Temp Offset	19
IU Mode	20
Multipan	21
Sous Chef Cloud Programming	24
USB Programming	25
Cleaning Guide	27
Temperature Check Procedure	29
RFHU Specification	30
Wire Diagrams	31-37

MANUFACTURER'S INTRODUCTION

The ReadyFlex™ Holding Unit (RFHU) delivers unsurpassed culinary performance for a broad variety of food products in a flexible, easy to use, easy to learn, adaptable format thus addressing the needs of the restaurant operations and profitability.

The Duke ideal holding curve, the DNA of the RFHU, has been developed, improved, and refined since Duke introduced the first product holding unit in 1999. Utilizing the innovative top and bottom patented Duke technology HeatSinks™, extended hold times with improved food quality and consistency are achieved.

With the ReadyFlex™ holding unit, you can offer new menu items without limitation on how to hold them; change your recipes and hold configurations by daypart; from breakfast to lunch to dinner. Independent top and bottom heat zones are programmable to dial in perfect recipes for any food....no compromises.

Utilizing an innovative lid system, the ReadyFlex™ holding unit is multi-pan capable, both 2.5" and 4" deep pan configurations can adapt to hold 1/2 and full-size pans, in addition to, 13x18" sheet pans. The Multi-pan feature is configurable and programmed without the use of any additional parts or tools.

The easy to use, easy to learn touchscreen user interface is visual, smart, intuitive and colorful. In-store control and programming is easy and fast - change to stored library recipes or program new ones on the fly. Daypart switching is simple and pre-programmed.

ReadyFlex™ Technology is ready to connect when (and if) you are. RFHU has built-in WI-FI, Ethernet, USB and Mesh networking and connectivity to Bluetooth enable devices. RFHU is ready to interact with 3rd party cloud and on-premise solutions.

Note: The RFHU is also available with a bottom only Duke technology HeatSink option that too provides improved holding times and food quality than traditional FWM PHU models at an even more compelling price.

Note: The RFHU is available with a dedicated lid system for those that choose to have fixed pan sizes for their operations.

IMPORTANT SAFETY INSTRUCTIONS

Throughout this manual, you will find the following safety words and symbols that signify important safety risks with regards to operating or maintaining the equipment.



Indicates a hazardous situation which, if not avoided, could result in death or serious injury.



Indicates a hazardous situation which, if not avoided, could result in minor or moderate injury.

CAUTION

Indicates Important Information



Indicates electrical shock hazard which, if not avoided, could result in death or serious injury and/or equipment damage.



Indicates hot surface which, if not avoided, could result in minor or moderate injury.

In addition to the warnings and cautions in this manual, use the following guidelines for safe operation of the unit.

- Read all instructions before using equipment.
- For your safety, the equipment is furnished with a properly grounded cord connector. Do not attempt to remove or disconnect the grounded connector.
- Install or locate the equipment only for its intended use as described in this manual.
- Do not use corrosive chemicals on this equipment.
- Do not operate this equipment if it has a damaged cord or plug, if it is not working properly, or if it has been damaged or dropped.
- This equipment should be serviced by qualified personnel only. Contact the nearest Duke authorized service facility for adjustment or repair.
- Do not block or cover any openings on the unit.
- Do not immerse cord or plug in water.
- Keep cord away from heated surfaces.
- Do not allow cord to hang over edge of table or counter.

IMPORTANT SAFETY INSTRUCTIONS

The following warnings and cautions appear throughout this manual and should be carefully observed.

- Turn the unit off, disconnect the power source and allow unit to cool down before performing any service or maintenance on the unit.
- The procedures in this manual may include the use of chemical products. You must read the Material Safety Data Sheets before using any of these products.
- The unit should be grounded according to local electrical codes to prevent the possibility of electrical shock. It requires a grounded receptacle with dedicated electrical lines, protected by fuses or circuit breaker of the proper rating, in accordance with all applicable regulations.
- Disposal of the unit must be in accordance with local environmental codes and/or any other applicable codes.
- This appliance is not intended for use by persons (including children) with reduced physical, sensory or mental capabilities, or lack of experience and knowledge, unless they have been given supervision or instruction concerning use of the appliance by a person responsible for their safety.
- Contains Transmitter Module FCC ID: 2AQ2Q-MUR1LVUFL
- Contains Transmitter Module IC: 27013-MUR1LVUFL.
- This device complies with part 15 of the FCC Rules. Operation is subject to the following two conditions:
 1. This device may not cause harmful interference, and
 2. This device must accept any interference received, including interference that may cause undesired operation.
- This equipment complies with radiation exposure limits set forth for an uncontrolled environment. This equipment should be installed and operated with a minimum separation distance of 20cm between the radiator (enclosed antenna) and your body.
- This device is granted for use in Mobile only configurations in which the antennas used for this transmitter must be installed to provide a separation distance of at least 20cm from all person and not be co-located with any other transmitters except in accordance with FCC and Industry Canada multi-transmitter product procedures.
- Changes or modifications not expressly approved by the party responsible for compliance could void the user's authority to operate the equipment.

INSTALLATION

UNPACKING UNIT

Inspect the shipping carton and/or container, carefully noting any exterior damage on the delivery receipt; also note any damage not evident on the outside of the shipping container (concealed damage). Contact the carrier immediately and file a damage claim with them. Save all packing materials when filing a claim. Freight damage claims are the responsibility of the purchaser and are not covered by the warranty.

- Follow the instructions on the Carton Box for unpacking the unit.
- Inspect unit for damage.
- Report any dents or breakage to source of purchase immediately.
- **Do not attempt to use unit if damaged.**
- Remove all materials from unit interior.
- If unit has been stored in extremely cold area, wait a few hours before connecting power.

INSTALLATION CODES AND STANDARDS

In the United States, the RFHU must be installed in accordance with the following:

1. State and local codes.
2. National Electrical Code (ANSI/NFPA No. 70, latest edition) available from the National Fire Protection Association, Batterymarch Park, Quincy, MA 02269.
3. Vapor Removal from Cooking Equipment, (NFPA-96, latest edition) available from NFPA.
4. Sealed to the counter upon which the equipment is placed per NSF/ANSI 4 standard.

In Canada, the RFHU must be installed in accordance with the following:

1. Local codes.
2. Canadian Electrical Code (CSA C22.2 No. 3, latest edition) available from the Canadian Standards Association, 5060 Spectrum Way, Mississauga, Ontario, Canada L4W 5N6.

UNIT PLACEMENT

- Do not install unit next to, below or above source of heat such as oven or deep fat fryer.
- Install unit on level counter top surface.
- Outlet should be located so that plug is accessible when the unit is in place.
- Do not install unit in the direct path of air-conditioned airflow.

The following minimum clearances must be maintained between the warmer and any combustible or non-combustible substance:

Unit	Clearance
Right Side	2"
Left Side	2"
Rear	OPEN
Floor	0"

Proper airflow around unit will cool the electrical components. With restricted airflow, the unit may not operate properly and the life of the electrical components may be reduced. A 2" clearance is recommended at the control side for longer control life expectancy.



ELECTRICAL SHOCK HAZARD UNIT MUST BE SAFETY GROUNDED, EARTHED. DO NOT MODIFY, DEFEAT ELECTRICAL CONNECTIONS OR ALTER PLUG.

ELECTRICAL CONNECTIONS

WARNING BEFORE CONNECTING THE UNIT TO THE POWER SOURCE, VERIFY THAT THE VOLTAGE AND PHASE OF THE POWER SOURCE ARE IDENTICAL TO THE VOLTAGE AND PHASE INFORMATION ON THE DATA LABEL.

EARTHING INSTRUCTIONS

THE UNIT MUST BE GROUNDED. Grounding reduces risk of electric shock by providing an escape wire for the electric current if an electrical short occurs. This unit is equipped with a cord having a grounding wire with a grounding plug. The plug must be plugged into a receptacle that is properly installed and grounded.

Consult a qualified electrician or service agent if grounding instructions are not completely understood, or if doubt exists as to whether the unit is properly grounded.

DO NOT USE AN EXTENSION CORD. If the product power cord is too short, have a qualified electrician install a three-slot receptacle (or the country specific receptacle for International Units). This unit should be plugged into a dedicated circuit with the electrical rating as provided on the product data plate.

STACKING UNITS

The RFHU is designed to allow limited stacking capabilities. This section outlines how to safely stack the holding unit.

Step 1 Remove the base pan from the unit that will be on top. The pan is held in place by four screws on the bottom of the unit.

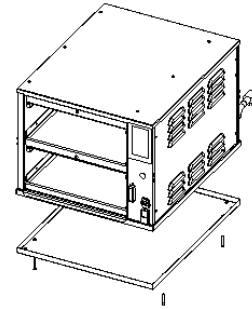

Step 2 Place bottom unit into position then stack the next unit on top. The top of the lower holding unit rests inside of the base of the upper unit.

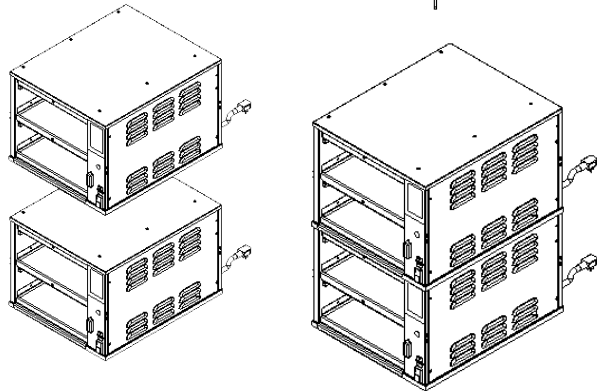

⚠ WARNING TIP HAZARD! DO NOT STACK RFHU UNITS THAT ARE 3 ROWS OR HIGHER. DO NOT EXCEED 2 HOLDING UNITS PER STACK. DO NOT PLACE HOLDING UNIT STACKS ON SURFACES THAT MAY EASILY TIP OVER.



PROPER USE OF HEATSINK™ COVERS

Proper usage of each is important and is outlined below:

Product Type	Dedicated 1/3 Size Lid Option
Broiled and Grilled	Solid Lid
Fried	No Lid

Consult your Kitchen Operations Manual for any modifications to the above based on your specific food requirements.

RFHU OPERATING INSTRUCTIONS

OVERVIEW

When the ReadyFlex™ Holding Unit is turned on the boot screen will appear first for 2 or 3 seconds. This will display the Duke Logo along with the firmware version number of the RFHU.



Different types of information are found on the runtime screen. Details below.

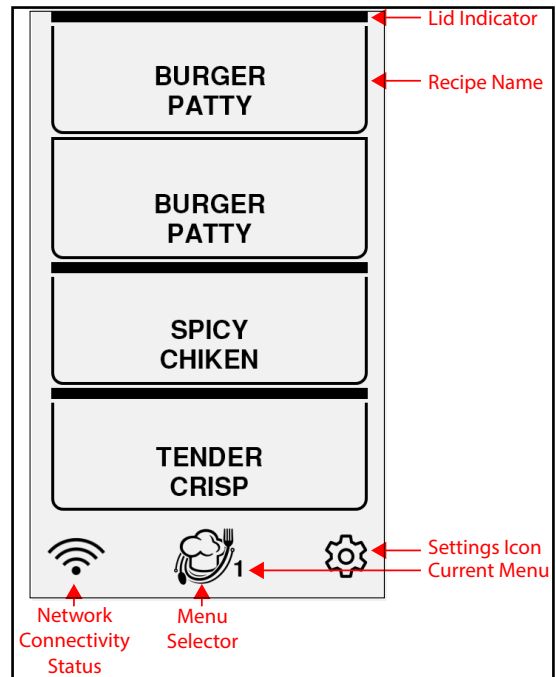

RUNTIME SCREEN

After the RFHU has loaded the runtime screen will load.

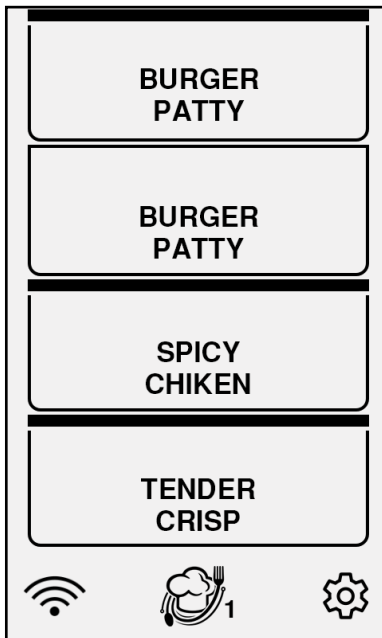

When the unit first boots each well will contain a preheating icon. This indicates the well is heating to temperature. When the recipe temperature is reached the preheat icon will clear and the well will be ready for use.

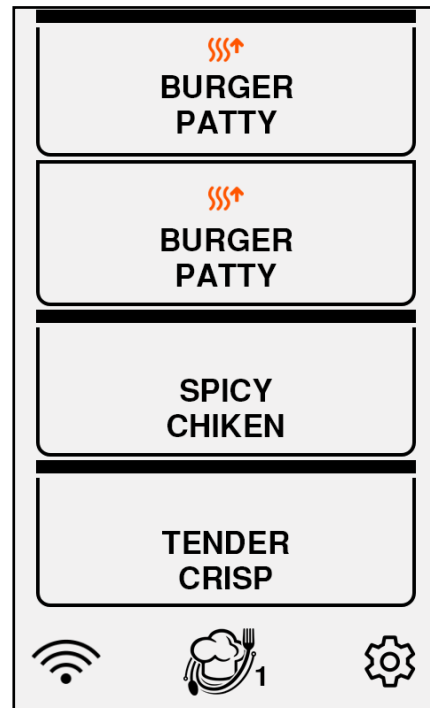

In this instance a 4X1 RFHU has been detected.

A "4X1" has a layout consisting of 4 rows by 1 columns containing up to 4 programmed recipes in total.

RFHU OPERATING INSTRUCTIONS - Continued

Each recipe is programmed with a "hold time". The hold time can be configured for any time between 1 minute to 720 minutes. Pressing on any well will start the timer.

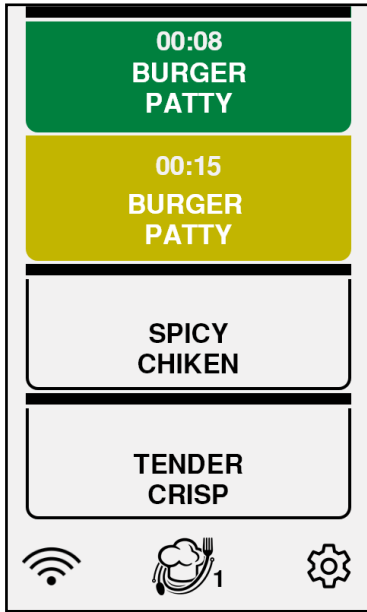

When a well is started the color of the well will change to green, use this product first. When the second well of the same recipe is started the started well change to amber, use this next. When subsequent wells of the same recipe are started, they will also be amber. If a different well is started with a different recipe and there is no other well running with the recipe - then it will also have green background.

When the well countdown timer expires, the timer shows a "X", the will turns red and an alarm will sound. Touching the well, cancels the alarm. To cancel an unexpired timer you must press and hold.



Three-day part menus are available to be selected on the runtime screen.

When selected these will change the recipe display.

For example, during Breakfast hours you may hold different recipes to lunch or dinner.

Changing from "Menu 1" to "Menu 2" will change all non-running programmed recipes name to the new menu layout.

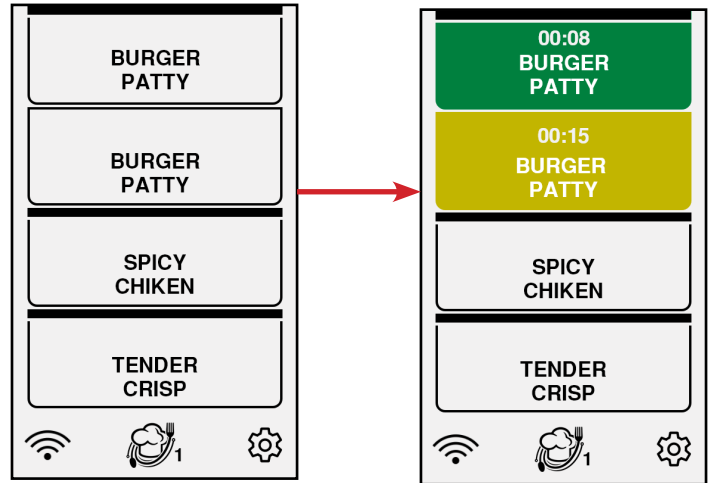

If a well is currently running and the menu is changed the new recipe name will not take effect until the well has been stopped or expired and cleared.

A Cook More time value can be programmed for each individual recipe. The "Cook More time" is used to indicate that the remaining hold time of the current recipe is low and they should start cooking/preparing the recipe once more.

A "+" symbol appears on the individual well with the cook more time indicator.

For example:

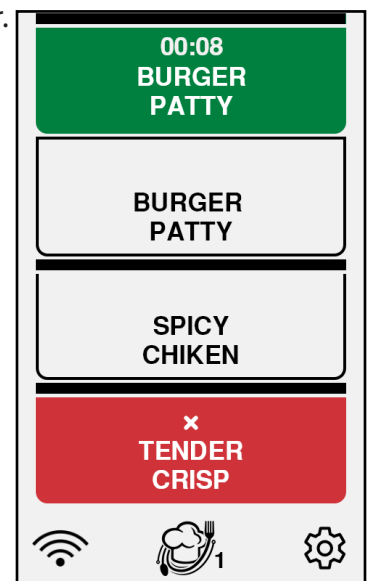

RFHU OPERATING INSTRUCTIONS - Continued

PREHEATING

When the RFHU first boots each well will contain a preheating icon. This indicates the well is heating to temperature. When the recipe temperature is reached the preheat icon will clear and the well will be ready for use.

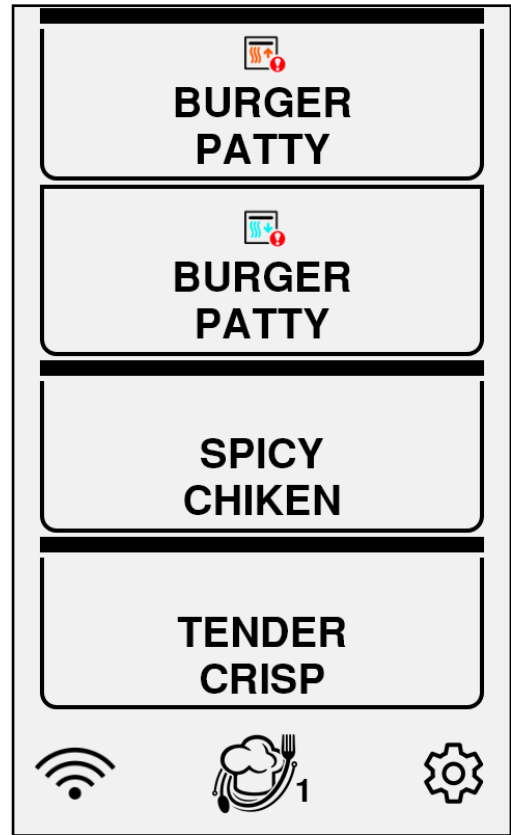
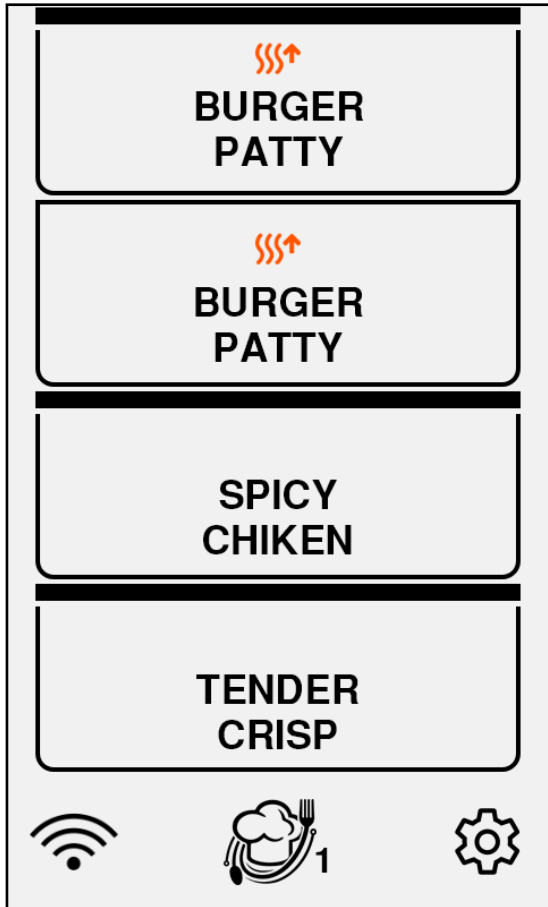

FAULTS

On occasion faults may occur on the RFHU. If a fault occurs an indicator will appear on the well and the well will not be usable (cannot start/stop timers).

1. Top Heater High Temperature Fault
2. Top Heater Low Temperature Fault
3. Bottom Heater High Temperature Fault
4. Bottom Heater Low Temperature Fault
5. CAN Error Fault
6. Back Screen Disconnected

Each fault will display an indicator that is unique for the top of fault that has appeared.

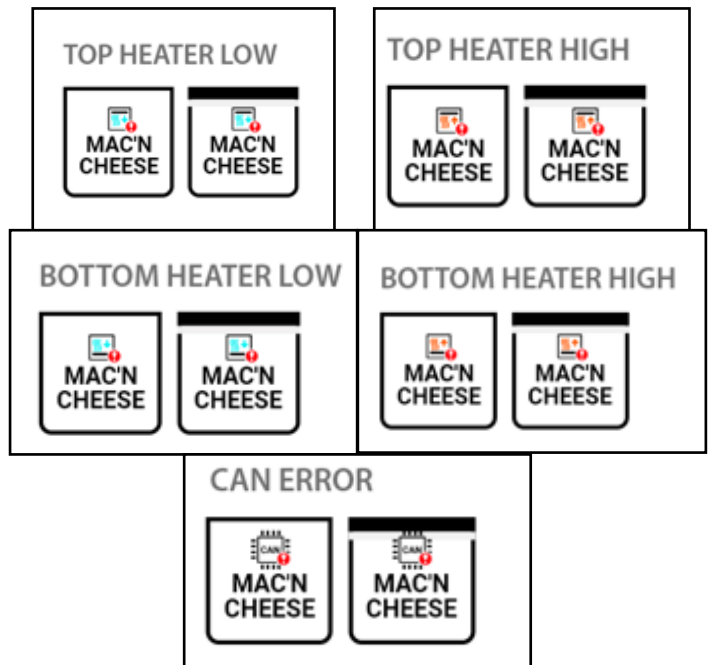

RFHU OPERATING INSTRUCTIONS - Continued

RFHU DAYPART MENU

To choose another menu, select the Menu Selector. This will display the Menu screen. Select another Menu number and then back to the runtime screen.

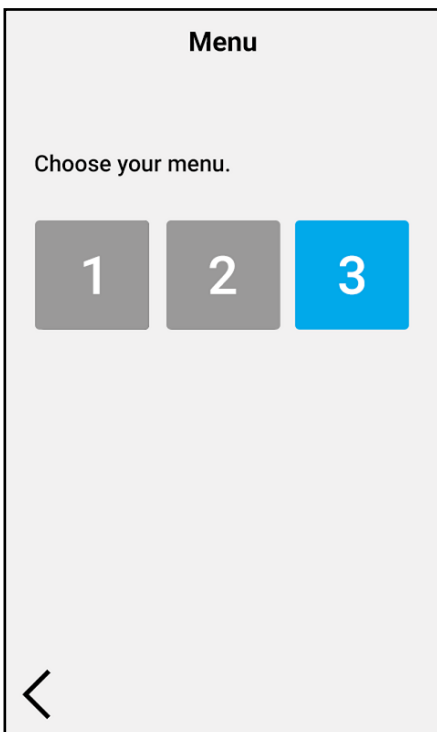
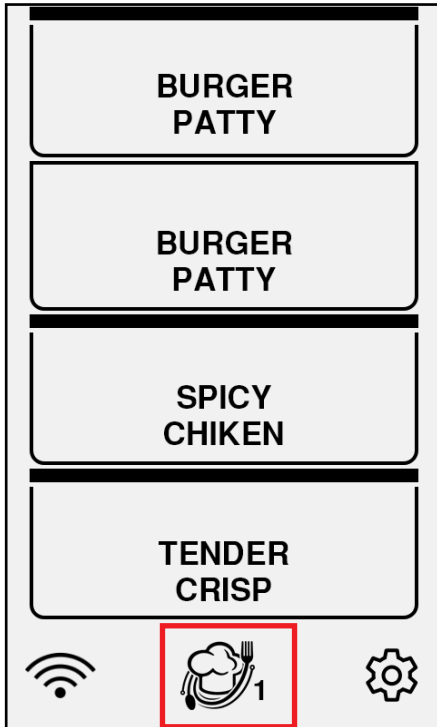

Units with optional Timer bar

TO ENSURE OPTIMAL HOLD QUALITY, THE USER WOULD PRESS THE BUTTON ON THE TIMER BAR CORRESPONDING WITH THE PAN LOCATION TO ACTIVATE A HOLD CYCLE.

THIS STARTS THE TIMER COUNTDOWN.

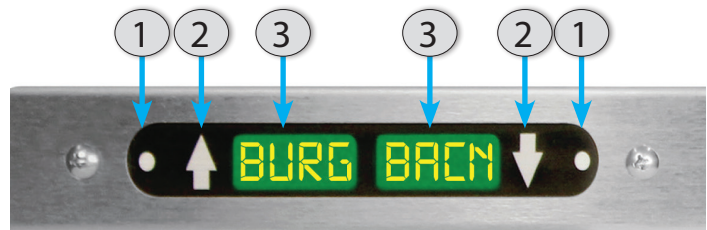

1. Status LED's: Indicates status of the pan

- Non-Illuminated – timer is inactive – no product in pan.
- Green – timer is active – product in pan (use 1st)
- Amber – timer is active – product in pan (use next)
- Non-Illuminated – timer active – product in pan (use later)
- Flashing Green – cook warning time reached (cook more product)
- Flashing Red – product is expired (discard)

2. Arrow buttons

- Used for starting and stopping the timer
- Used to access menu mode
- Indicates which pan the adjacent status LED and pan display are linked to

3. Pan Display

- In startup mode it will display spinning bars then transition to PRE HEAT, and then cycle through the bottom actual temp and top actual temp
- Once unit reaches the recipe set points it will display product name. (If associated recipe requires a lid display will toggle prod name, lid.)
- Unit will display product name and hold time remaining (display will alternate between the two when a timer is active)

RFHU OPERATING INSTRUCTIONS - Continued

- **ENSURE PROPER HEAT SINK COVERS ARE INSERTED INTO THE CORRECT LOCATION (BROILED AND MOISTURE SENSITIVE PRODUCTS ONLY).**
- **ENSURE METAL TRIVETS ARE INSERTED INTO THE PANS FOR FRIED PRODUCTS.**
- **UPON TURNING ON, ALLOW THE HOLDING UNIT TO HEAT FOR AT LEAST 30 MINUTES OR UNTIL THE TEMPERATURE DISAPPEARS AND THE TIMER BARS DISPLAY THE PRE PROGRAMMED PRODUCT NAMES.**
- **IF THE TIMER BARS DISPLAY "HIGH" OR "LOW" AT ANY TIME AFTER THE PRE-HEAT PERIOD, DISCONTINUE USE OF THE AFFECTED PAN LOCATION(S) UNTIL THE HOLDING UNIT CAN BE SERVICED.**

Menu Mode

1. Press and hold the paired arrows for a display segment for 3 seconds to enter Menu Mode. Display will toggle (NAME, product name)
2. 1ST button press will display (ACT TEMP, actual temp bottom, actual temp top)
3. 2ND button press will display (SET TEMP, temp set point bottom, temp set point top)
4. 3RD button press will display (TIME, receptive in minutes)
5. 4TH button press will display (LID, ON or OFF)
6. 5TH button press will display (COOK MORE TIME, cook more time in minutes)
7. 6TH button press will display (FIRM, actual firmware version)
8. 7TH button press will display (LED display will light all LEDs in a testing sequence)

RFHU OPERATING INSTRUCTIONS - Continued

SETTINGS

Several Settings are available on the RFHU. To enter the Settings menu click on the cog icon (⚙️) which is found in the lower right hand corner of the runtime screen.

Menu

The "Menu" option is allows you to select the number Menus (or dayparts) you want to be available (1 to 3).

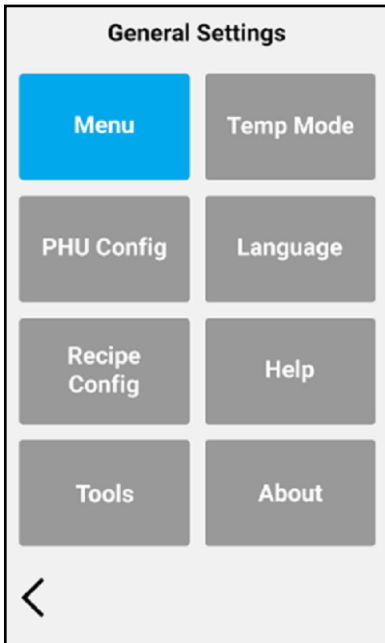

Temp Mode

"Temp Mode" will display an option where the temperature mode can be changed from the default of Fahrenheit to Celsius.

NOTE: Any temperature throughout the control will display in the selected temperature mode.



PHU Configurator

When the user loads the "RFHU Config" menu option within Settings the following screen will appear.

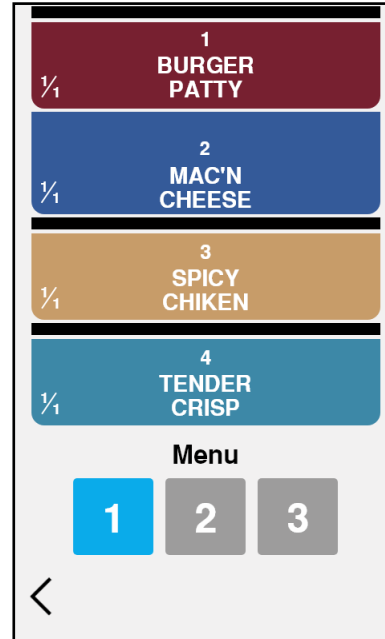

In the same way as the runtime screen the unit's configuration (for example 4X1) will be detected and displayed.

The PHU config option allows the recipe mapping of each well to be modified for each menu.

In the below example, a 4x1 setup with a 1/2 size multipan configuration is shown. The number in the middle of each zone along with the color indicates that the individual wells are within the same temperature zone.

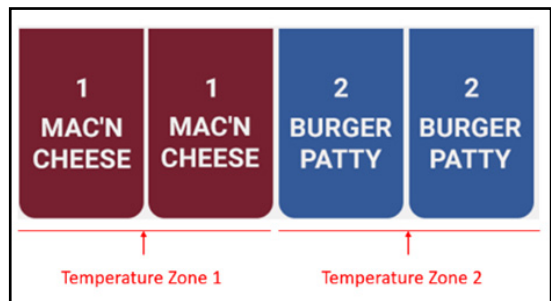

Current well mapping is displayed. For example "MAC'N CHEESE" is selected for both wells in "Zone 1". When programming, only recipes with the same BOTTOM (and TOP) temperature can be configured next to each other within the same temperature zone.

RFHU OPERATING INSTRUCTIONS - Continued

When an individual well is pressed a list of available recipes will appear available for selection within the zone, for example:



Use the left and right navigation buttons to scroll through the available recipes for this RFHU. To assign a new recipe to the well, simply select the desired recipe.

Select to exit without making a change.

Select to save and update the RFHU Configuration.

When the user returns to the runtime screen and the well has stopped, the new recipe name will appear where programmed.

Note: If a change is made and there is a current recipe running, the new recipe name will not take affect until the previous receipt has stopped/ expired or been cleared.

Language

“Language” Setting. This is reserved for future use and will allow RFHU users to change the language display on all screens.

RFHU Recipe Editor

Selecting the “Recipe Config” option will display the list of local recipes currently stored on the unit. These are sorted alphabetically

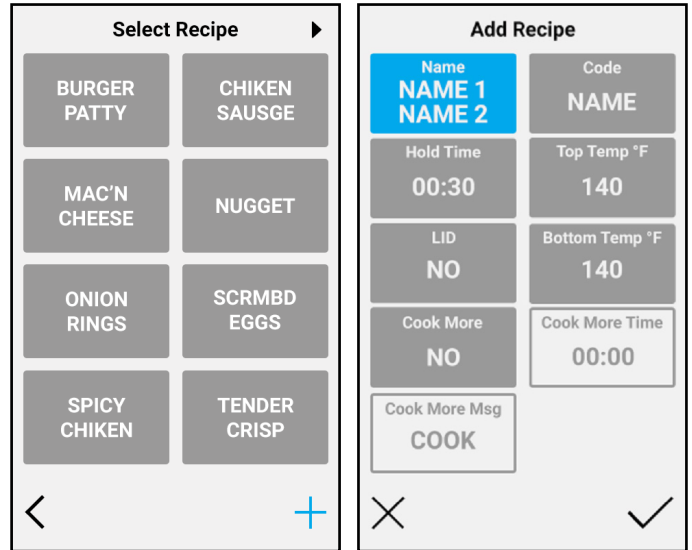

Key information on each recipe is displayed on this screen view. This includes the Recipe Code, 2 fields for the Recipe Name (appears on the well on the runtime screen), the Hold Time, Cook More Time, Top temperature and the Bottom Temperature.

Page navigation buttons can be used on each screen to navigate through each set of recipes.

The “+” icon can be used to add a new local recipe. Selecting on an existing recipe will load the recipe in edit mode.

Each of the 9 recipe fields can be modified here.

The Duke ReadyFlex unit comes preprogrammed with generic recipes installed on the unit and provided in the software. These recipe recommendations were developed for 1/3 size pan configurations, when utilizing the flexible lid system to accommodate larger pan capacities temperature adjustments are recommended. When increasing pan capacity for fried products start with using 30-degree (F) temperature increase for both top and bottom heat and if holding moist products start with using a 10-degree (F) temperature increase for both top and bottom heat. To optimize the holding performance of the Duke ReadyFlex unit additional temperature adjustments may be necessary.

RFHU OPERATING INSTRUCTIONS - Continued

Help

When selecting Help option the Help screen will load with a QR code. When scanned this will link to this manual hosted on the cloud.



About

The "About" screen will detail specific settings available to the RFHU.

This will include the unit's serial number, API key, firmware version along with the unique network MAC address used for both WiFi and ethernet connectivity.



Tools Menu

The following configurations are available on the TOOLS menu.

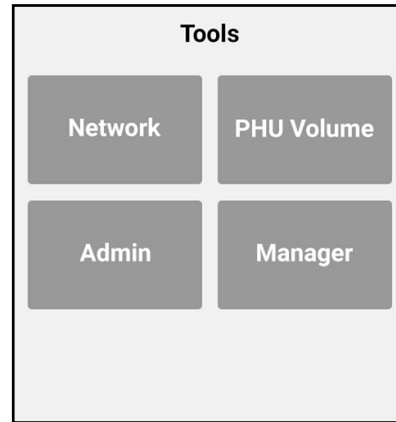

Network

The Network Config option will allow the RFHU network connection to be configured. After selecting "Network Config" the following screen will load.

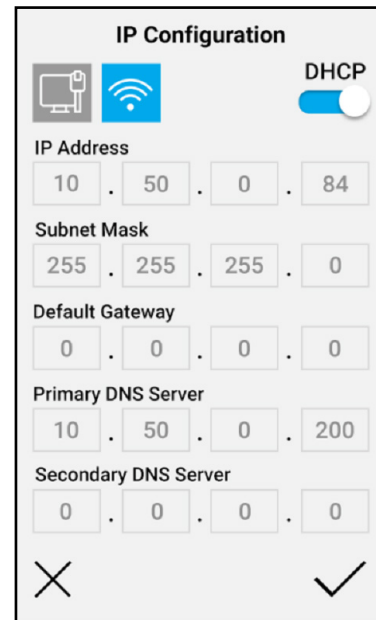

Network Config can be set to "Read Only" mode if the access is locked within Tools menu. Alternatively, if "Network" is unlocked in the Access menu then changes can be made to the selected network.

The RFHU supports both WiFi and Ethernet connections. In each network mode, both automatically assigned IP addresses (DHCP) and manually entered static IP addresses are supported.

To modify Network Settings first ensure that Network Settings are unlocked in the Access Menu (they are by default). Then enter the "Network" option found within the "Tools" menu.

RFHU OPERATING INSTRUCTIONS - Continued

The current network selection will be highlighted, either Ethernet or WiFi. For example:

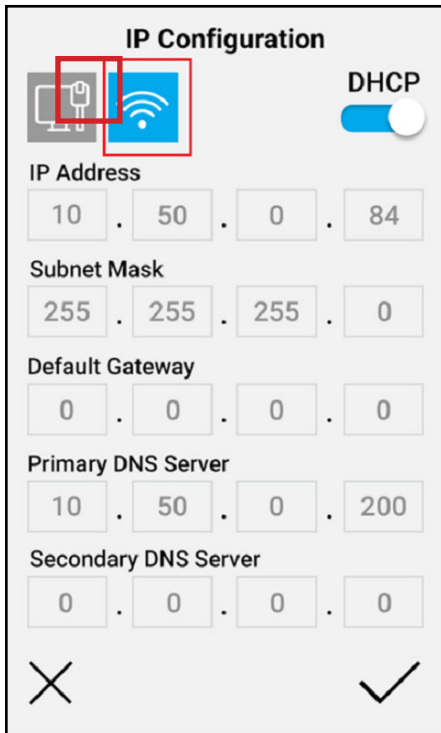

To connect to a WiFi SSID click on the SSID name. The Wifi SSID password will then be required.



To change to WiFi select the WiFi icon () near the top of the Network Config screen. A list of available WiFi SSID's will then appear.

Press anywhere within the "Enter Password" box to load the on-screen keyboard to enter the WiFi password.

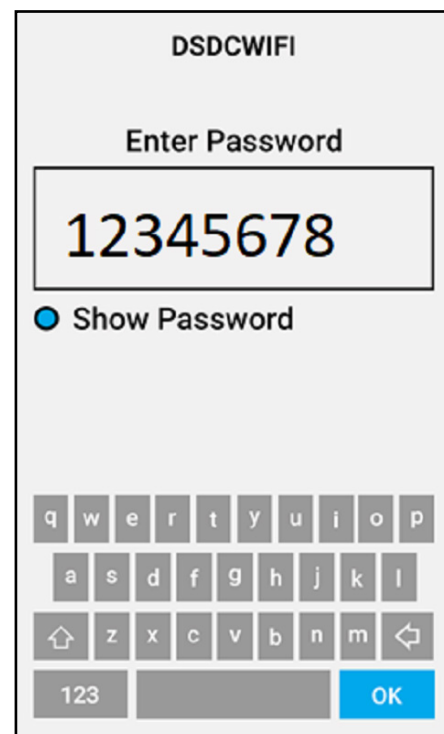

RFHU OPERATING INSTRUCTIONS - Continued

Once entered select "OK" on the on-screen keyboard followed by the check button to attempt to join the WiFi SSID.

If the WiFi password is incorrect the RFHU will not join the WiFi network. If the WiFi password is correct the RFHU will join the network and the RFHU will be connected.

If the RFHU is currently connected to a WiFi network the connected SSID will be displayed in blue.

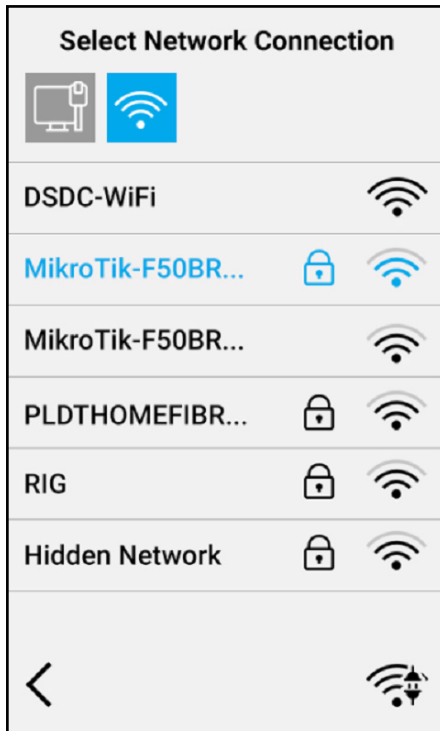

To disconnect from the WiFi select the disconnect icon (📶) in the lower left hand corner of the RFHU or alternatively click on another WiFi SSID to join a different WiFi network (WiFi password entry will then be required).

The "DHCP" toggle is available for both ethernet and WiFi connections. By default DHCP will be selected. Instead of being assigned an IP address automatically a static IP address will allow the network settings (IP Address, Subnet Mask, Default Gateway, Primary DNS Server, Secondary DNS Server) to be manually configured and saved.

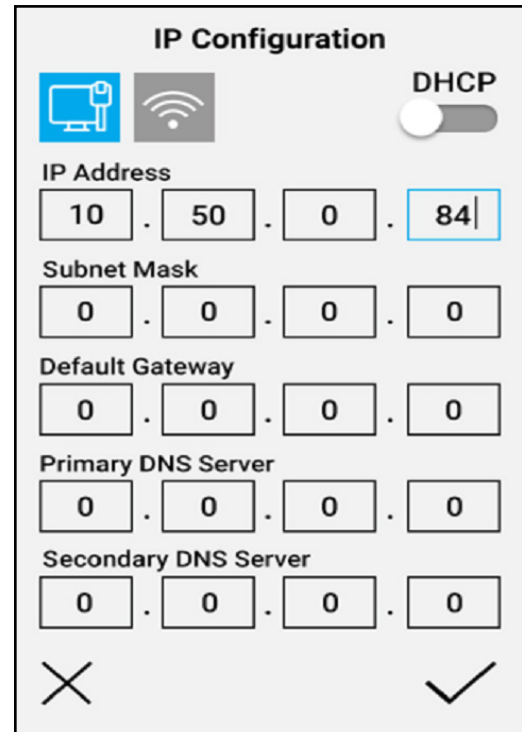

Selecting on any of the 5 Network Settings will load an on-screen numeric keypad where the IP address details can be entered manually.

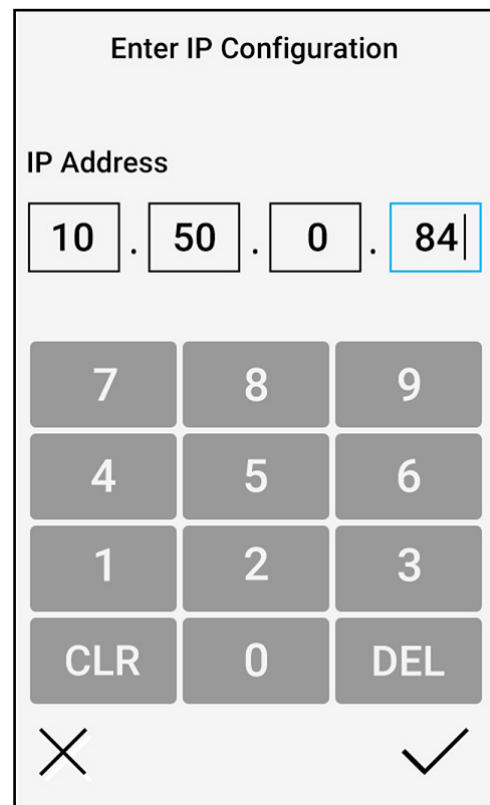

Once entered select the check button to save the newly entered settings.

RFHU OPERATING INSTRUCTIONS - Continued

PHU Volume

The PHU Volume option will either enable or disable sound on the RFHU.

The slider can be moved either on or off.

Select to save and update the PHU Volume Configuration.

Select to exit without making a change.

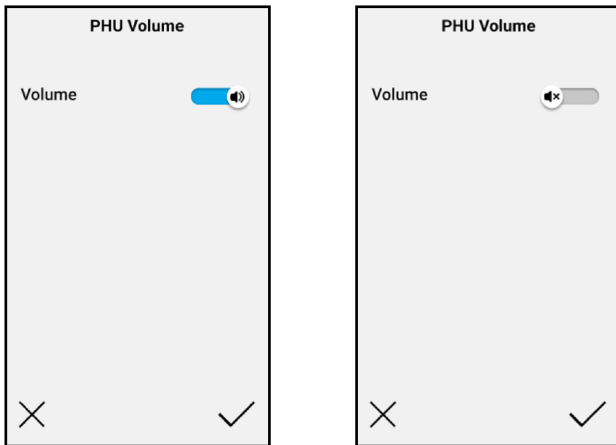

Admin

The "Admin" options is reserved for future use.

Manager

The MANAGER menu is PIN code protected and allows the 'manager' access to the ACCESS, TEMP OFFSET and UI MODE functions.

Selecting "MANAGER" the following screen will be displayed.



Enter PIN "8429" and select and the following screen will be displayed.

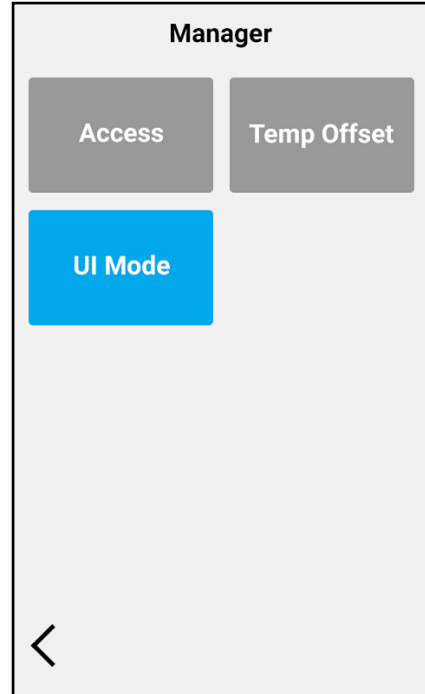

Access Menu

The ACCESS menu allows a number of configuration options to be "locked" or unable to be changed. When selected the following screen will appear.

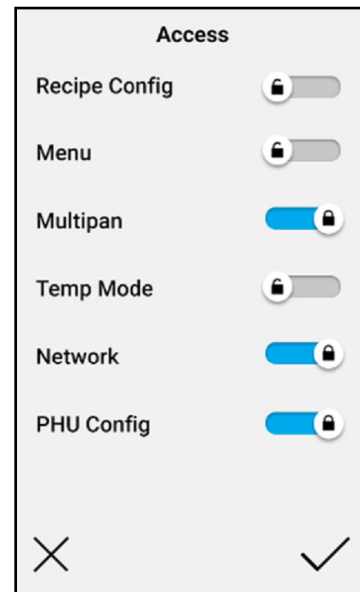

Each of the Recipe Config, Menu, Multipan, Temp Mode (C/F), Network and PHU Config can be locked or unlocked.

For example, if "Recipe Config" is locked when the Recipe Config option described previously is loaded it will be in "VIEW MODE" only. Modifications such as editing existing recipe settings, delete a recipe or adding a new recipe will not be available.

RFHU OPERATING INSTRUCTIONS - Continued

Temp Offset

The Temperature Offset function will allow the temperature offset to be adjusted per ZONE on the selected RFHU.

After selecting the "TEMP OFFSET" function the following screen will appear.

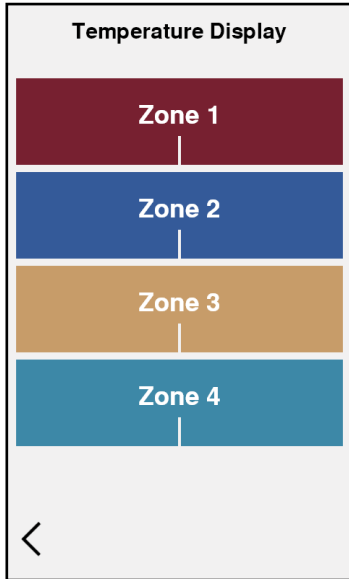

The screen will be divided into a grid like display. Instead of each "colored area" indicating a well it will now indicate a "Zone". In most PHU configurations a "Zone" generally means the two wells next to each other – however there may be exceptions to this rule. Select a zone.

After selecting a zone the following screen will appear.

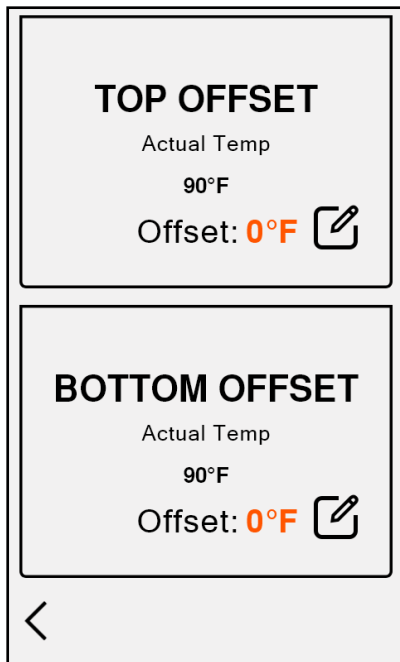

When this screen appears the TOP and BOTTOM current temperature offset value will appear. The actual temperature read from the RFHU for both the top and bottom heaters will also appear.

The edit icon (✎) will load the offset editor screen for either "Top Offset" or "Bottom Offset".

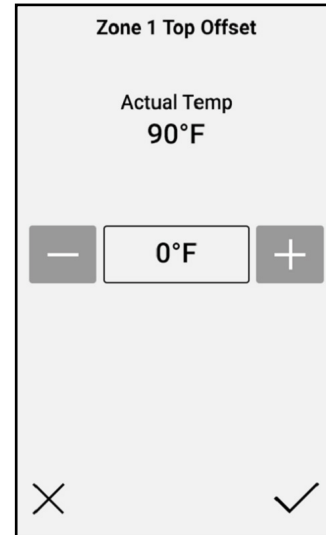

Once again the current temperature will be displayed. The current offset value will also be displayed.

The **-** and **+** can be selected to increase the offset value by 1F each press.

Select **✕** to exit without making a change. Select **✓** to save and update the offset value.

RFHU OPERATING INSTRUCTIONS - Continued

UI MODE

The UI Mode option found in the Manager menu will allow the user to set the display to either a single line recipe name of 14 characters length or two line recipe name of 6 characters per line.

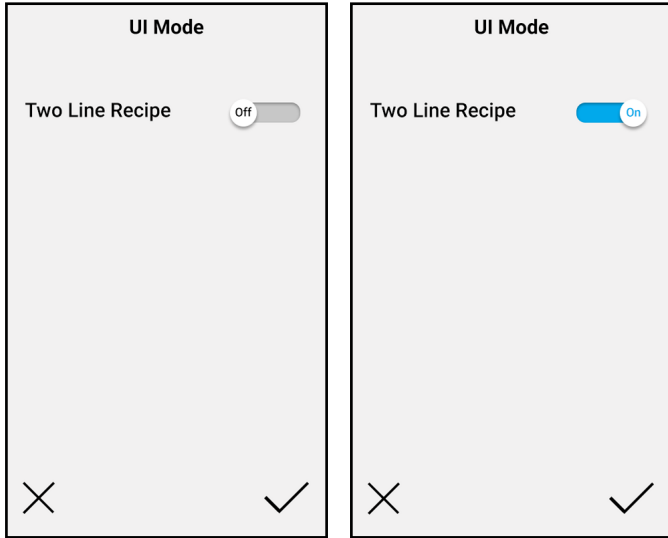

When changing to the single line recipe name, the PHU configuration screen and Runtime screen will be adjusted with the new setting accordingly. Therefore, after changing the UI mode setting to single line recipe name and returning to the runtime screen, the display would change to the below.

Recipes appear over 1 line with maximum of 14 characters.

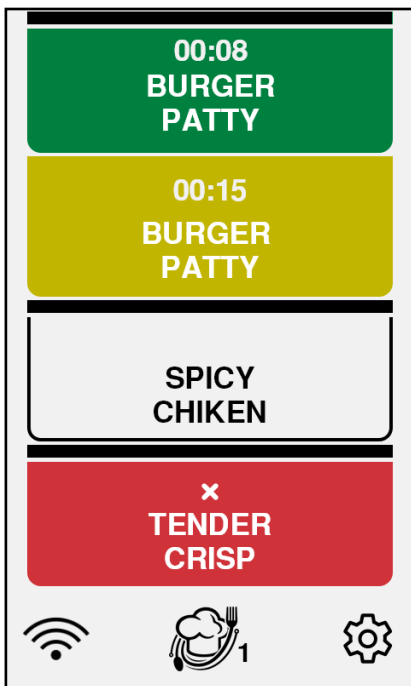

Re-entering the recipe config screen will display the recipe information as a single line recipe name.

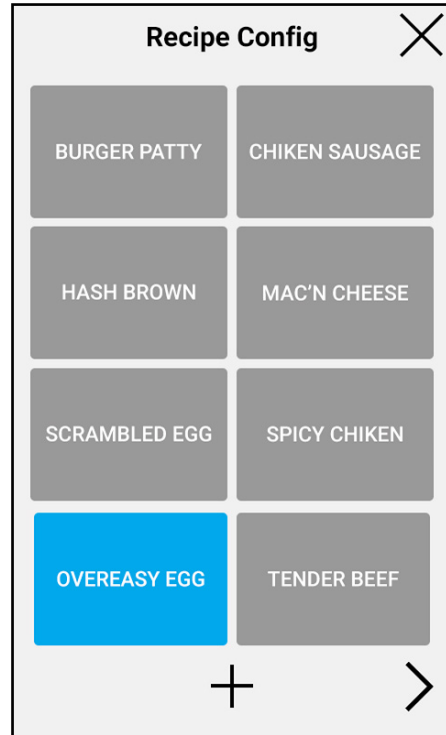

When selecting a recipe to edit or "+" to add a new recipe, the single line recipe field will be displayed automatically instead of the two recipe line names.

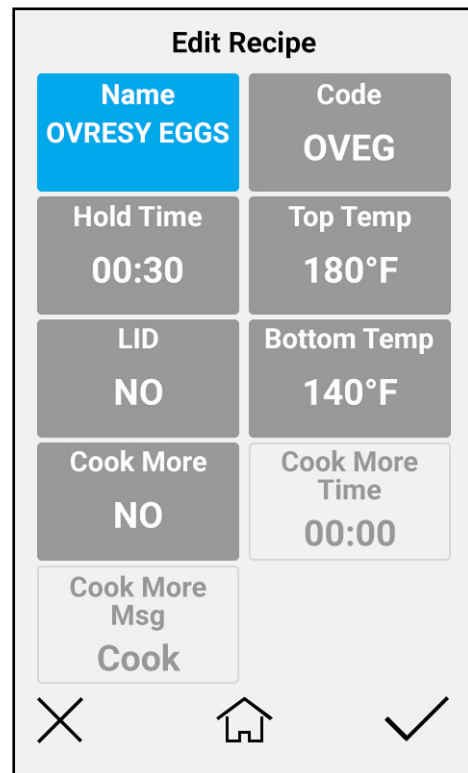

RFHU OPERATING INSTRUCTIONS - Continued

When modifying the long recipe name an alpha-numeric keyboard will appear on the screen and be used for modification of the recipe name.



After modifying the recipe names, the long description will also be displayed on the PhU configurator screen.

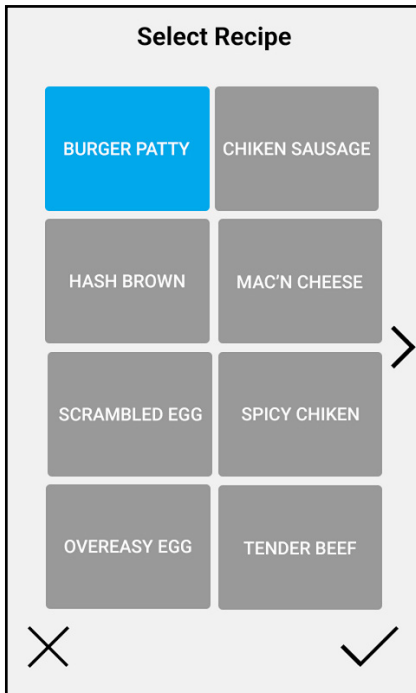

MULTIPAN

Enabling Multipan will allow 1/2 and full size pans to be configured on the RFHU in numerous available multipan configurations for that PHU.

After enabling Multipan in ACCESS, the PHU Configurator can be accessed.

There is now a new icon to select the Multipan configuration in the bottom right hand corner.

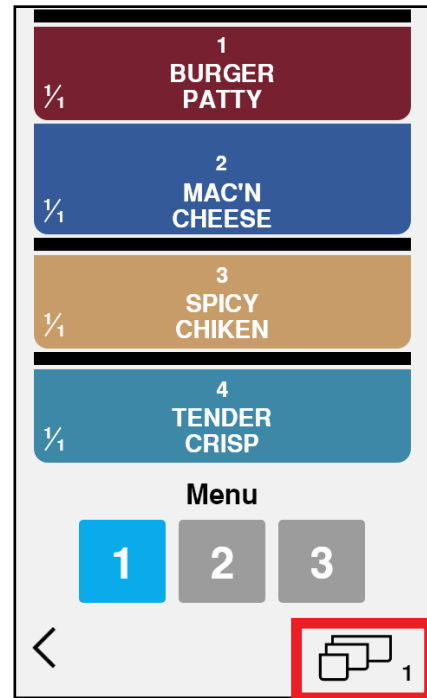

By default the Multipan configuration will be "1". This will be all 1/1 size pans for the appropriate RFHU configuration.

RFHU OPERATING INSTRUCTIONS - Continued

After selecting the Multipan icon the following screen will appear.

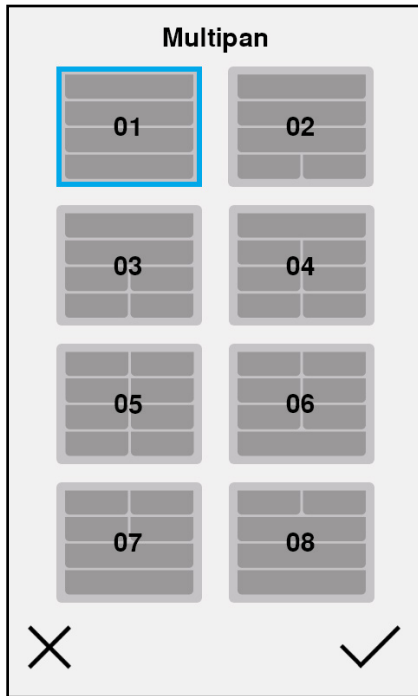

After selecting a configuration, for example "3" the pho configuration screen will change to the new layout, in this case; two 1/1 pans followed by 2 rows of 1/2 size pans.

A different Multipan layout can be selected for each available menu (3). For example Menu 1 could have Multipan layout "5" and Menu 2 could have Multipan layout "7".

Recipes can then be assigned to each well in the same manner.

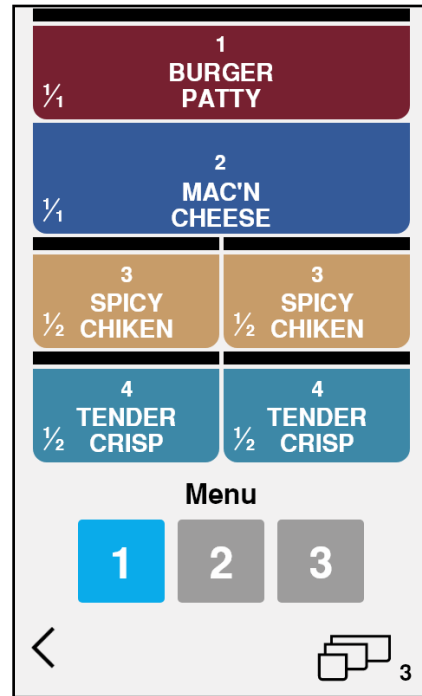

After selecting the Multipan configuration, the runtime screen will be updated with the Multipan configuration. Wells can be started and stopped in the same manner.

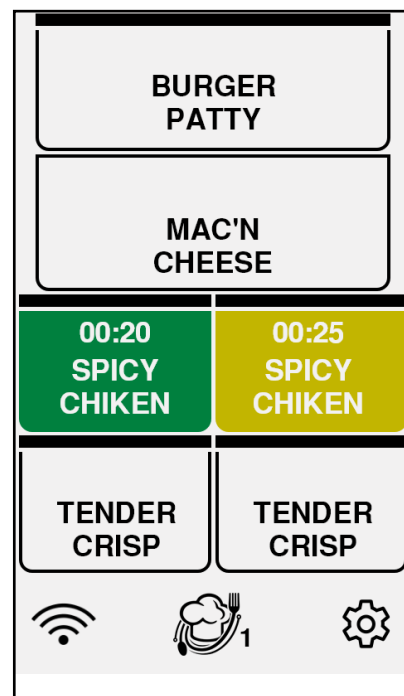

RFHU OPERATING INSTRUCTIONS - Continued

Re-entering the PHU Config screen can allow other Multipan configurations to be selected. For example; selecting Multipan layout "5" will display the following on the PHU Configuration screen.

The corresponding runtime screen will then be displayed as the following once wells have been started.

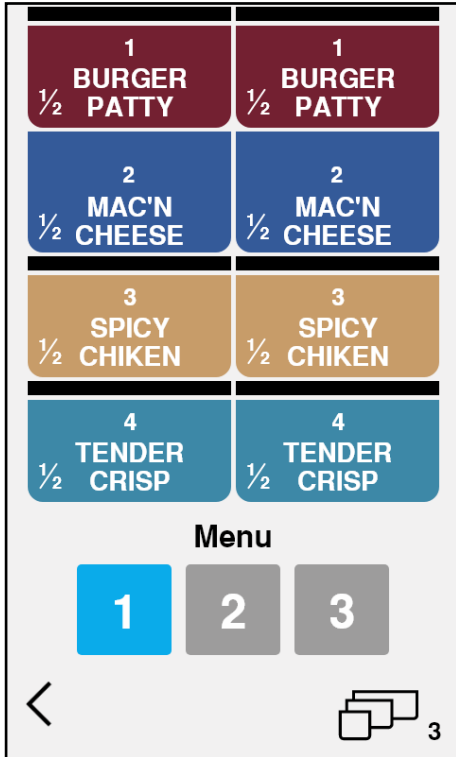

RFHU OPERATING INSTRUCTIONS - Continued

Sous Chef Technology Programming

The ReadyFlex™ Holding Unit can have its recipes and well programming updated locally on the RFHU Control as mentioned in previous sections. Recipes and well programming can also be updated via Duke's cloud solution – the Sous Chef Cloud.

The Sous Chef Cloud requires the user's Account Name to be defined along with a user login and password. This can be created via the Sous Chef Cloud registration process without the assistance of Duke Customer Service. An option exists for this purpose on the souscheftech.com landing page – "Create an Account".

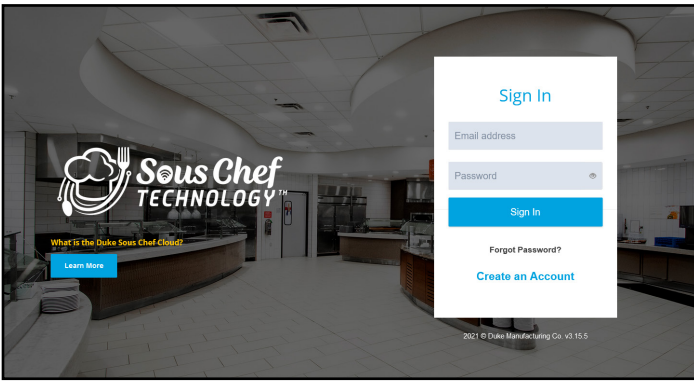

The ReadyFlex™ Holding Unit can then be added to the account using its serial number and API key which can be found on the unit itself.

After logging onto the Sous Chef Cloud all connected devices within the account will be displayed. Multiple RFHU's are possible to be loaded within the account.

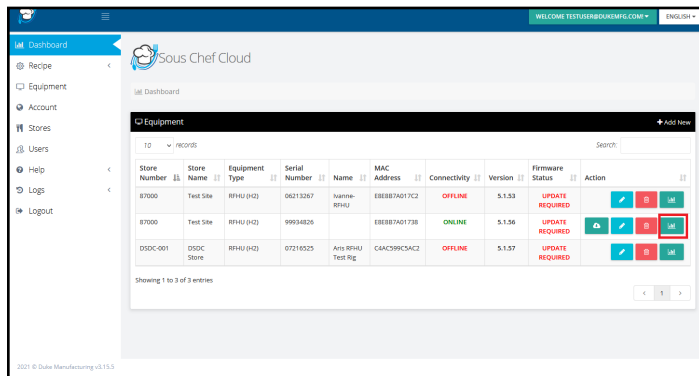

After selecting the "Dashboard" icon to connect to a specific RFHU the programming grid will appear. As this is a connected unit the unit configuration will be detected automatically, for example a 4X1F RFHU configuration appears below.

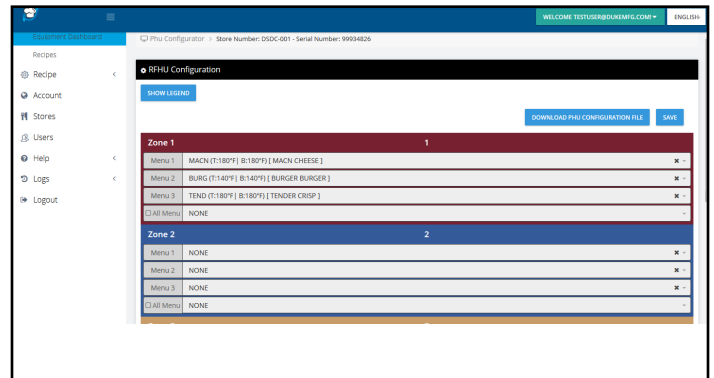

The RFHU programming grid will be color coded per zone. Recipes programmed within each zone will be required to be of the same top temperature and bottom temperature.

Three MENU's are available for selection for each well. The three menu's may be used as BREAKFAST, LUNCH or DINNER. The "All Day" option can be used when the well holds the exact same recipe for the entire day.

To program a well select the dropdown boxes next to each MENU. A list of available recipes will be displayed.

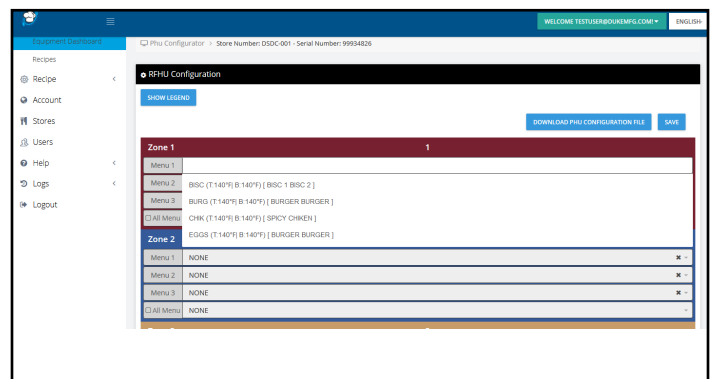

RFHU OPERATING INSTRUCTIONS - Continued

The "SHOW LEGEND" button can also be used to display the full recipe list for the full account.

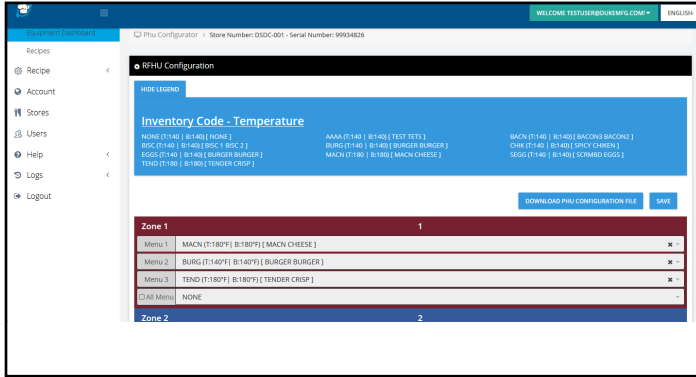

When grid programming has been completed a completely programmed PHU looks like the below.

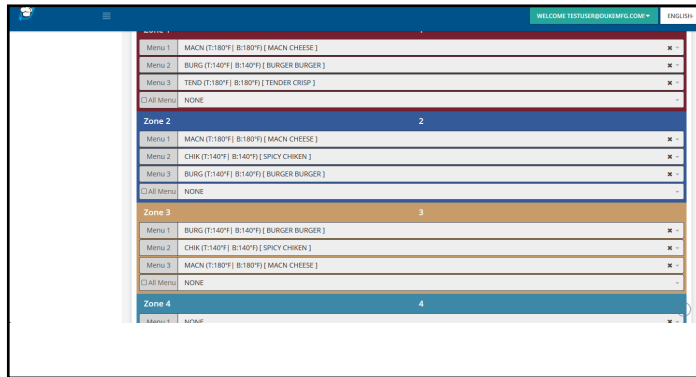

After programming the wells two options are then available. "DOWNLOAD PHU CONFIGURATION FILE" will create a local RCP formatted file with the programming. Alternatively, the "SAVE" button can be selected. This will update the well programming on the unit instantly from the Sous Chef Cloud to the RFHU unit itself. This is a real-time recipe program update.

Another option available within the Sous Chef Cloud is to be able to view the online RFHU Recipe List. This is available by selecting "Recipes" under "Equipment Dashboard" on the Sous Chef Cloud side menu.

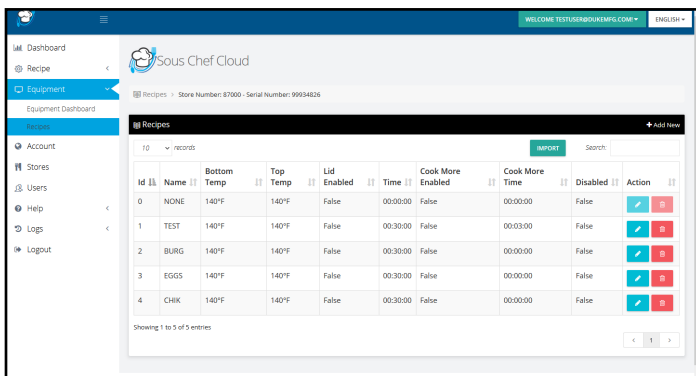

A list of local recipes found on the RFHU will appear here.

These can be edited, added, or deleted using the appropriate function which will update the connected RFHU local recipe set in real-time.

Selecting "Create Recipe" will load the following form where a new recipe can be added. Fields between "add" and "edit" are the same.

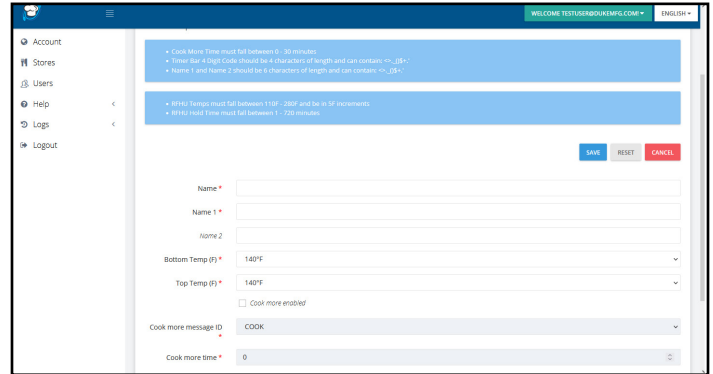

Fields consist of Recipe Name, Bottom Temp, Top Temp, Cook More enabled, Cook More Message ID, Cook more time, enabled/disabled and lid enabled/disabled. When finished adding or editing select the "SAVE" button. The updated recipe list will be sent to the connected RFHU where it is updated in real time.

USB Programming

In some cases the connected RFHU unit may not be online and connected to the Sous Chef Cloud. If this is the case the RFHU recipe and programming settings can be modified on the actual unit UI or alternatively the RFHU Offline Configurator menu option can be used on the Sous Chef Cloud.

This can be found under "Recipe" menu on the side menu of the Sous Chef Cloud.

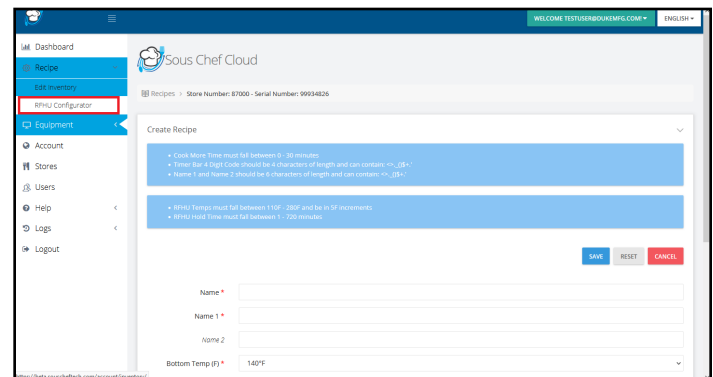

RFHU OPERATING INSTRUCTIONS - Continued

For the user's Account an "offline recipe set" will always be available to the user. This information will be saved and be readily available if a USB file is required to be created.

The RFHU Configurator is available for well programming.

As the unit is not connected the RFHU configuration, for example 4X1 or 2x2, will not be automatically detected.

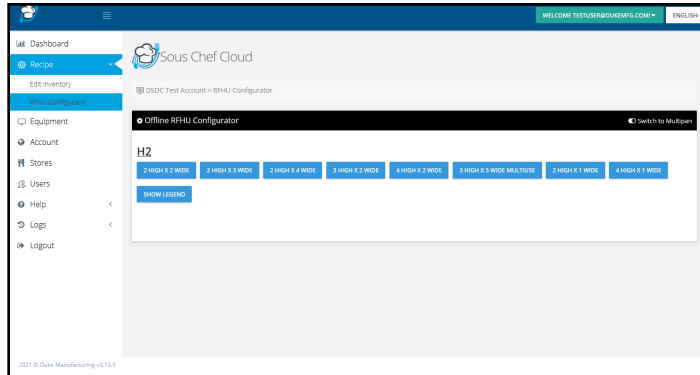

Instead a list of available configurations will be available for programming.

These include:

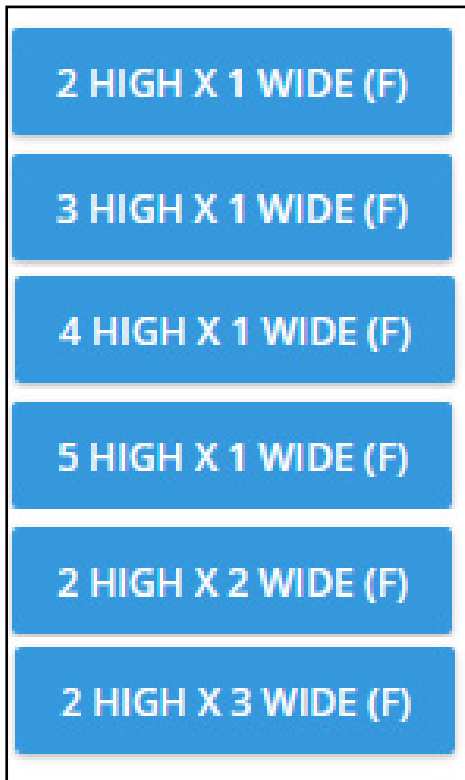

When a selected PHU configuration is selected the appropriate programming grid will appear. For example a 2x3 will appear as:

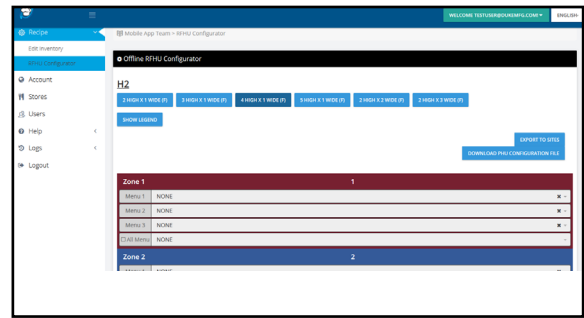

This can then be programmed in the same way as the online RFHU. For example:

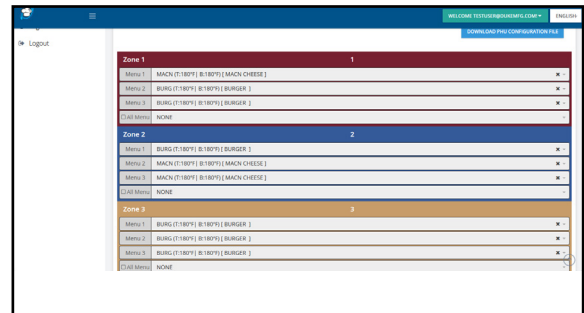

When finished select "DOWNLOAD PHU CONFIGURATION FILE" option. This will create a RFHU "RCP" file which contains both the recipe list and well mapping settings.

This file can then be copied to the "root" directory of a USB flash drive.

Plug this same USB drive into the USB port on an RFHU and if the configuration is correct both the recipe list and well programming will be uploaded on the unit itself. A confirmation message will appear on the RFHU display when a new recipe set has been successfully loaded.

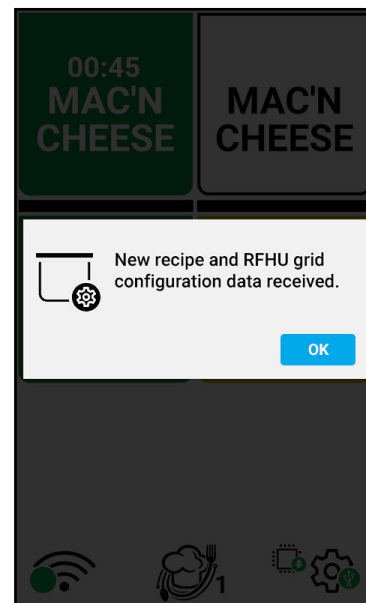

CLEANING GUIDE

⚠ CAUTION  Electrical shock hazard. Do not wash with water jet or hose.

DO NOT USE CAUSTIC CLEANERS, ACIDS, AMMONIA PRODUCTS OR ABRASIVE CLEANERS OR ABRASIVE CLOTHS. THESE CAN DAMAGE THE STAINLESS STEEL AND PLASTIC SURFACES.

⚠ WARNING  Bottom and sides of warmer wells are very hot and cool slowly.

DAILY CLEANING

• Stainless Steel Surfaces

To prevent discoloration or rust on stainless steel several important steps need to be taken. Stainless steel contains 70-80% iron which will rust. It also contains 12-30% chromium which forms an invisible passive film over the steel surface which acts as a shield against corrosion. As long as the protective layer is intact, the metal will not corrode. If the film is broken or contaminated, outside elements can begin to breakdown the steel and begin to form rust or discoloration.

Proper cleaning of stainless steel requires soft cloths or plastic scouring pads.

⚠ CAUTION

Never use steel pads, wire brushes or scrapers.

Cleaning solutions need to be alkaline based or non-chloride cleaners. Any cleaner containing chlorides will damage the protective film of the stainless steel. Chlorides are also commonly found in hard water, salts and household and industrial cleaners. If cleaners containing chlorides are used, be sure to rinse repeatedly and dry thoroughly upon completion.

Routine cleaning of stainless steel can be done with soap and water. Extreme stains or grease should be cleaned with a non-abrasive cleaner and plastic scrub pad. It is always good to rub with the grain of the steel. There are also stainless steel cleaners available which can restore and preserve the finish of the steels protective layer.

Early signs of stainless steel breakdown can consist of small pits and cracks. If this has begun, clean thoroughly and start to apply stainless steel cleaners in an attempt to restore the passivity of steel.

⚠ WARNING NEVER USE AN ACID BASED CLEANING SOLUTION! MANY FOOD PRODUCTS HAVE AN ACIDIC CONTENT WHICH CAN DETERIORATE THE FINISH. BE SURE TO CLEAN ALL FOOD PRODUCTS FROM ANY STAINLESS STEEL SURFACE. COMMON ITEMS INCLUDE, TOMATOES, PEPPERS AND OTHER VEGETABLES.

⚠ WARNING THE POWER MUST BE TURNED OFF AND DISCONNECTED AT ALL TIMES WHEN PERFORMING MAINTENANCE OR REPAIR FUNCTIONS.

CAUTION NEVER USE A HIGH-PRESSURE WATER WASH FOR THIS CLEANING PROCEDURE AS WATER CAN DAMAGE ELECTRICAL COMPONENTS

CAUTION ELECTRICAL SHOCK HAZARD. DO NOT WASH WITH WATER JET OR HOSE.

RECOMMENDED SUPPLIES

Cleaning Towels

Non-Scratch Scrub Pad

KAY™ Degreaser

KAY® SINK SANITIZER, KAYQUAT™ Sanitizer, or compatible sanitizer

CLEANING GUIDE - continued

PROCEDURE

1. Turn unit off, unplug, and allow to cool for 30 minutes.
2. Remove all holding pans and heat sink covers. Wash, rinse, and sanitize at the 3 compartment sink.
3. Allow to air dry.
4. Spray a cleaning towel, or non-scratch scrub pad when necessary, with soapy solution or KAY™ Degreaser. Fully clean upper heat sink surfaces by hand, as well as lower heat sink surfaces

CAUTION

Take care when reaching in the cabinet. Pan and lid guides present sheet metal edges which could be sharp.

NOTE: Never spray cleaning solution directly onto the cabinet.

5. If daily cleaning is performed routinely, deeper, more aggressive, cleaning methods can be avoided. Over longer periods of time, fried food product can accumulate and bake on to the upper heat sink surfaces of the compartments.
6. Use a sanitizer-soaked towel and wipe out all compartments on the holding unit. Wipe top compartments first, and then lower compartments.

IMPORTANT: Use clean, sanitizer-soaked towels (Important: towels must be wrung out so that they are damp and not dripping, dripping towels may harm the unit.)

DAILY INSPECTION CHECKLIST:

Make sure that:

- Unit is free of any visible food soils.
- Unit is free of grease or soils in holding compartment.
- Exterior of unit is free of smudges or soil.
- Holding pans are free of any food soil residue.
- Pans are free of damage such as cracks.

TEMPERATURE CHECK PROCEDURE

1. A digital temperature meter that has been calibrated must be used to get an accurate temperature reading. Use a thermocouple surface temperature probe to measure temperatures.
2. **No pans should be in wells during the pre-heat and temperature check.** Pre-heat the warmer for 30 minutes before taking any temperature readings. Do not take readings unless the cavity has been empty for 30 minutes. This will allow the temperature to stabilize and will prevent false readings.
3. The warmer cavity should be cleaned and empty before the temperature is checked. Avoid any air drafts that might flow through the cavity.
4. Temperature readings should be taken when standing on the front side of the unit with on/off switch. Locate the surface temperature probe on the bottom of the first cavity. Position the probe half way back on the heat sink and centered between the rail as shown. Two and three wide units require 2 and 3 readings, respectively.
5. All temperature controls exhibit a swing in temperature as the control cycles on and off while regulating to the set point. The correct calibration temperature is the average of several readings taken over a period of 20 minutes after the warmer has been pre-heated. The average temperature should be no greater than $\pm 10^{\circ}\text{F}$ ($\pm 6^{\circ}\text{C}$) from the set point.
6. The allowable range of well temperatures which can be programmed on the RFHU is 140°F - 280°F (60°C - 137.8°C).
7. If the calibration temperature is greater than $\pm 10\text{F}$ (6C) from the set point, adjust the temperature offset as described under the Tools menu. The offset value should be set as the difference between the calibration temperature and the set point.
8. Repeat for all heat sinks.

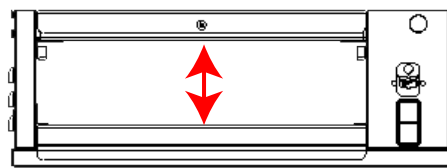

Center Probe Front to Back

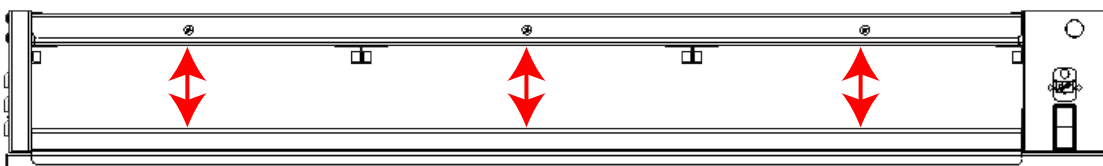
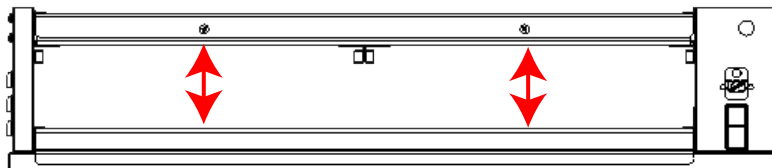

RFHU SPECIFICATIONS

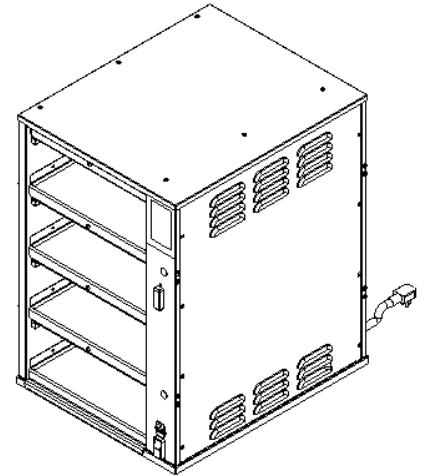
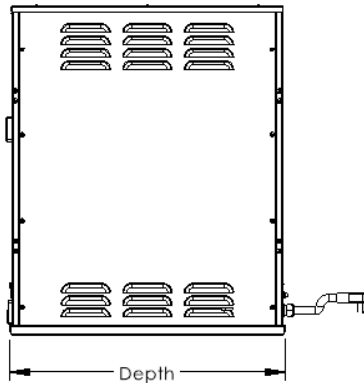
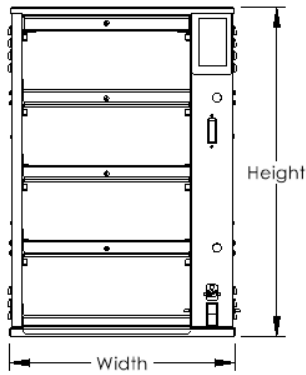

RFHU-41F Shown Above

ELECTRICAL SPECIFICATION/CORD RATING (TOP AND BOTTOM HEAT)

Model	120V - 60Hz		208/240 V - 60Hz		220/240V - 50/60Hz	
	Amps	NEMA	Amps	NEMA	Amps	Schuko
RFHU-21F	7.5	5-15P	6.5/7.5	6-15P	7.2	CEE7/7 (16A)
RFHU-31F	11	5-15P	10.8/12.5	6-20P	12	CEE7/7 (16A)
RFHU-41F	11	5-15P	13/15	6-20P	14.3	CEE7/7 (16A)
RFHU-51F	N/A	N/A	13/15	6-20P	14.3	CEE7/7 (16A)
RFHU-22F	11	5-15P	13/15	6-20P	14.3	CEE7/7 (16A)
RFHU-23F	N/A	N/A	13/15	6-20P	14.3	CEE7/7 (16A)
RFHU-52F	N/A	N/A	21.6/25	6-30P	23.9	CEE7/7 (32A)

DIMENSIONS

Model	Width		Depth		Height					
					2.5" Deep Pan		4" Deep Pan		Hybrid Pan	
	in.	cm	in.	cm	in.	cm.	in.	cm	in.	cm
RFHU-21F	18.5	47.0	22.5	57.2	11.9	30.2	14.5	36.8	13.2	33.5
RFHU-31F	18.5	47.0	22.5	57.2	16.7	42.4	20.7	52.6	18	45.7
RFHU-41F	18.5	47.0	22.5	57.2	21.4	54.4	26.7	67.8	24.1	61.2
RFHU-51F	18.5	47.0	22.5	57.2	26.2	66.5	32.8	83.3	28.8	73.2
RFHU-22F	32.2	81.8	22.5	57.2	11.9	30.2	14.5	36.8	13.2	33.5
RFHU-23F	45.9	116.6	22.5	57.2	11.9	30.2	14.5	36.8	13.2	33.5
RFHU-52F	32.2	81.8	22.5	57.2	26.2	66.5	32.8	83.3	28.8	73.2

WIRE DIAGRAMS



RFHU-21F Wire Diagram ELC0792 Rev B

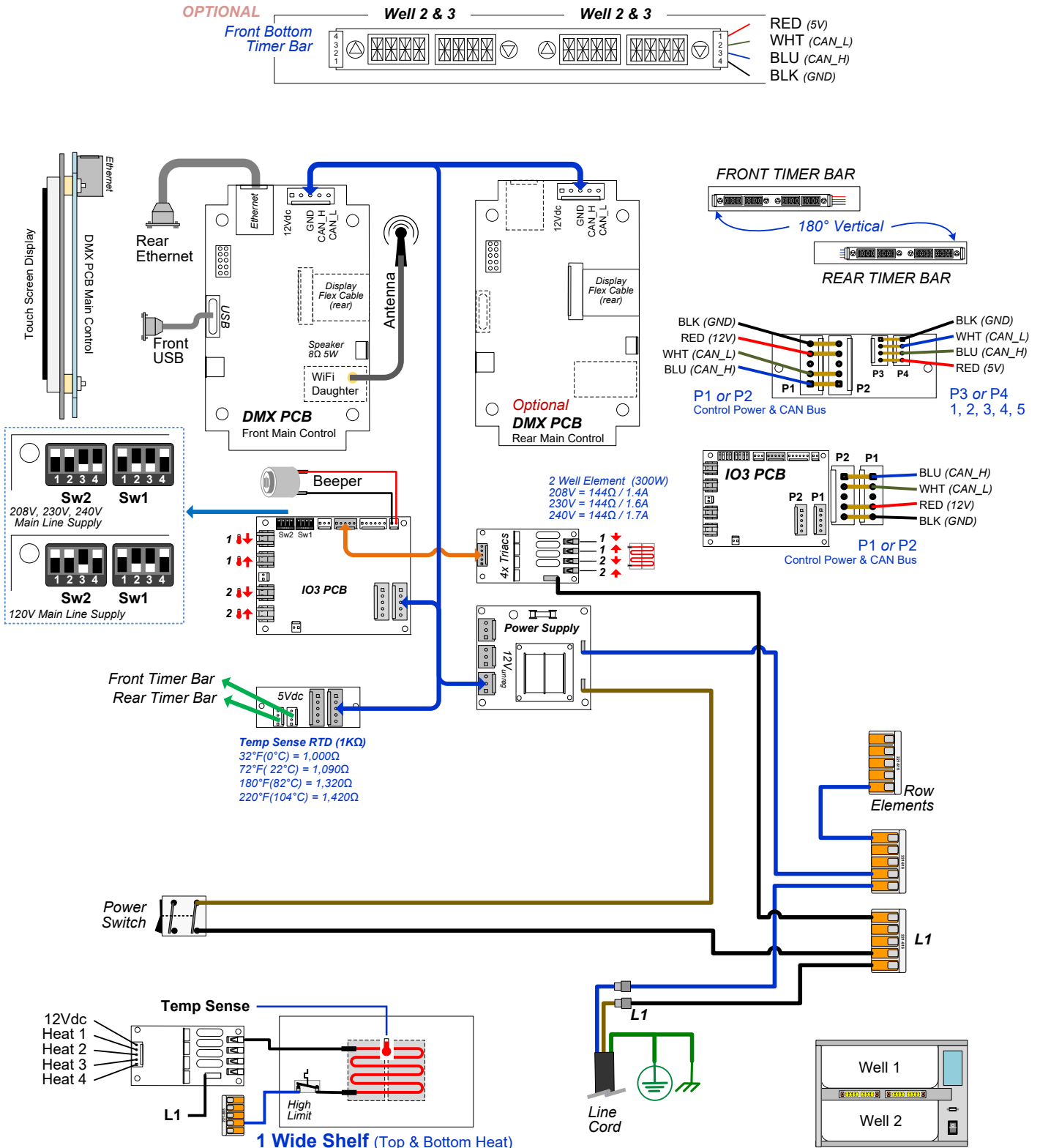

WIRE DIAGRAMS



RFHU-41F Wire Diagram ELC0790 Rev B

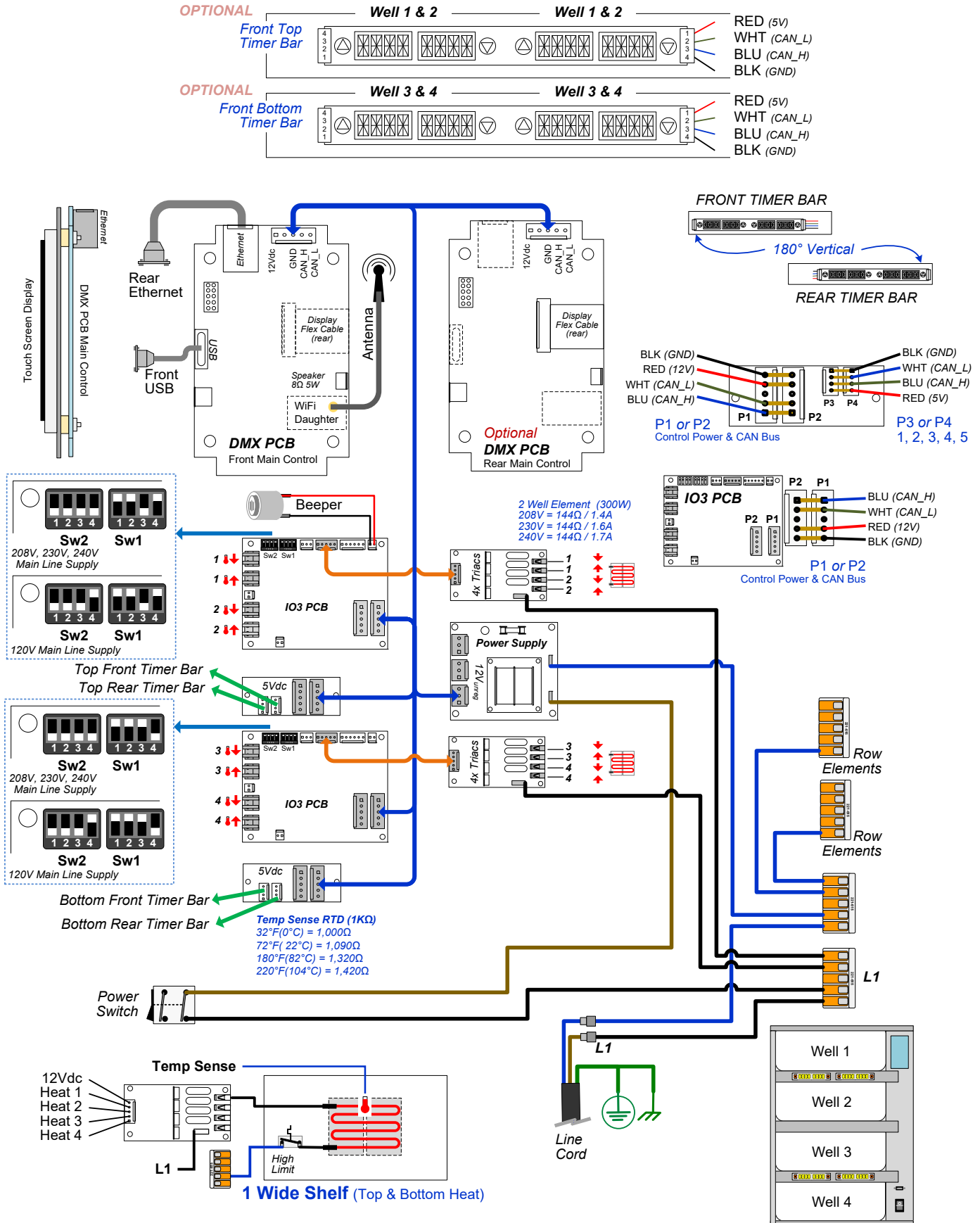

WIRE DIAGRAMS



RFHU-51F Wire Diagram ELC0789 Rev B

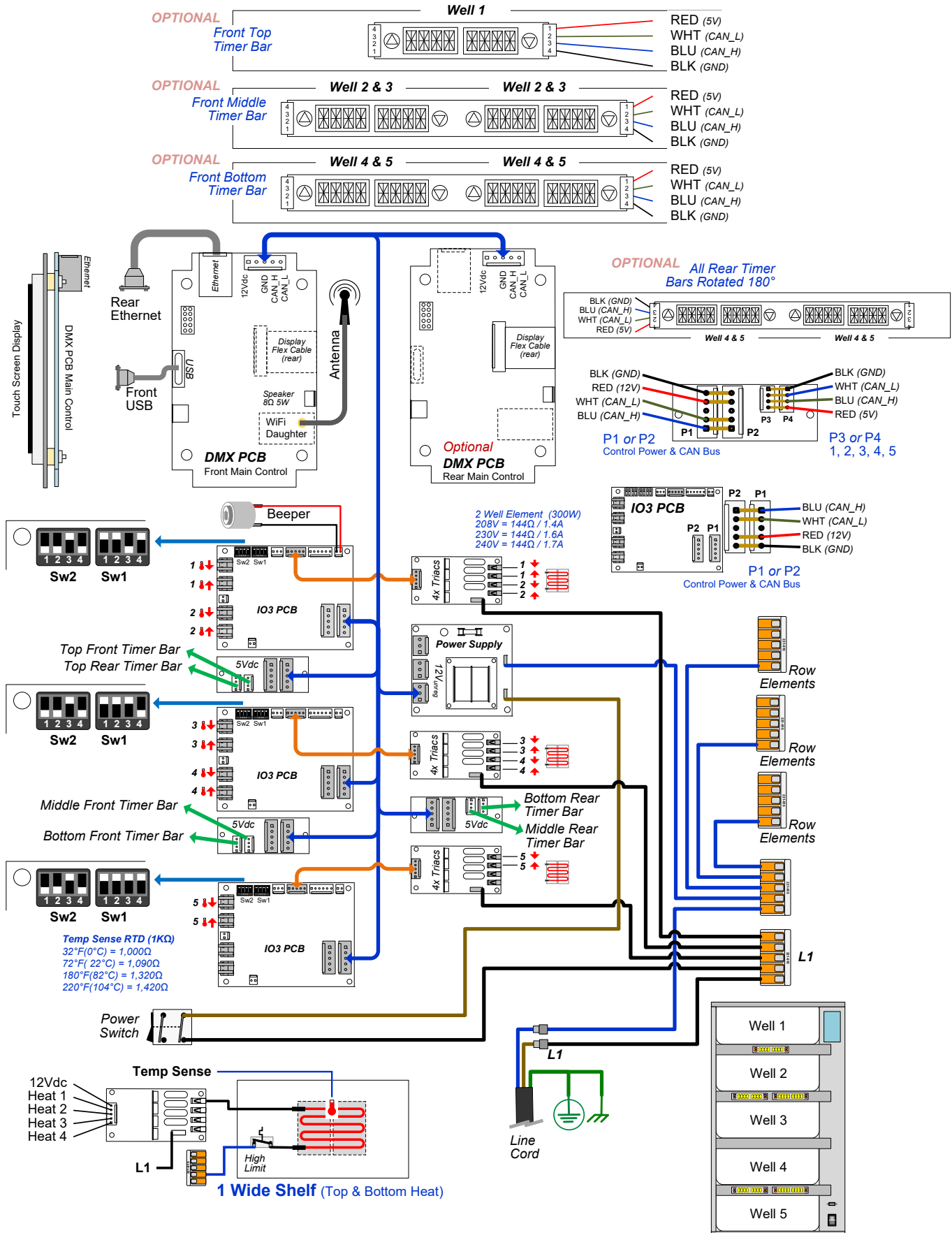

WIRE DIAGRAMS



RFHU-22F Wire Diagram

ELC0812 Rev B

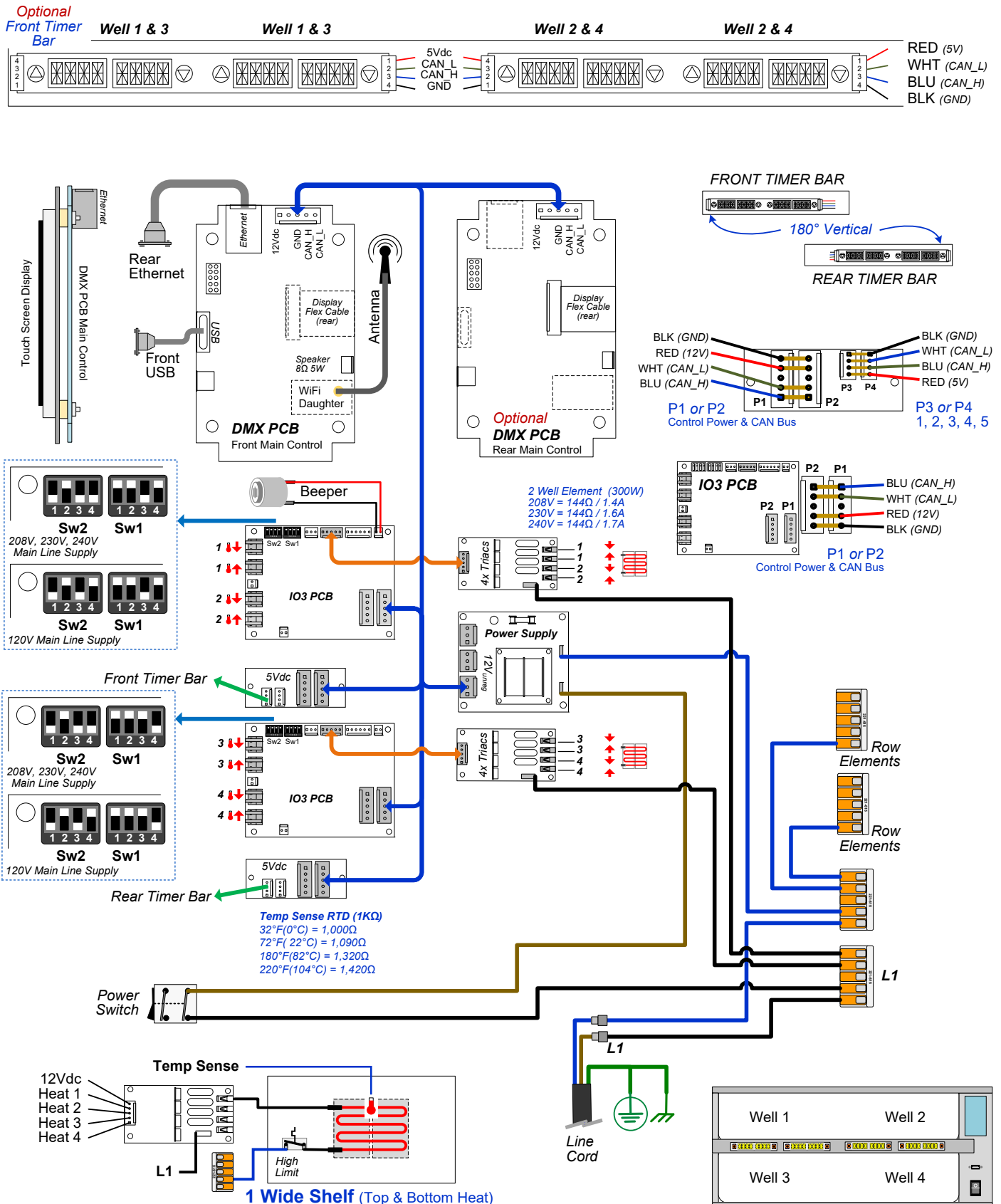

WIRE DIAGRAMS

RFHU-23F Wire Diagram ELC0813 Rev. B

Optional Front Timer Bar

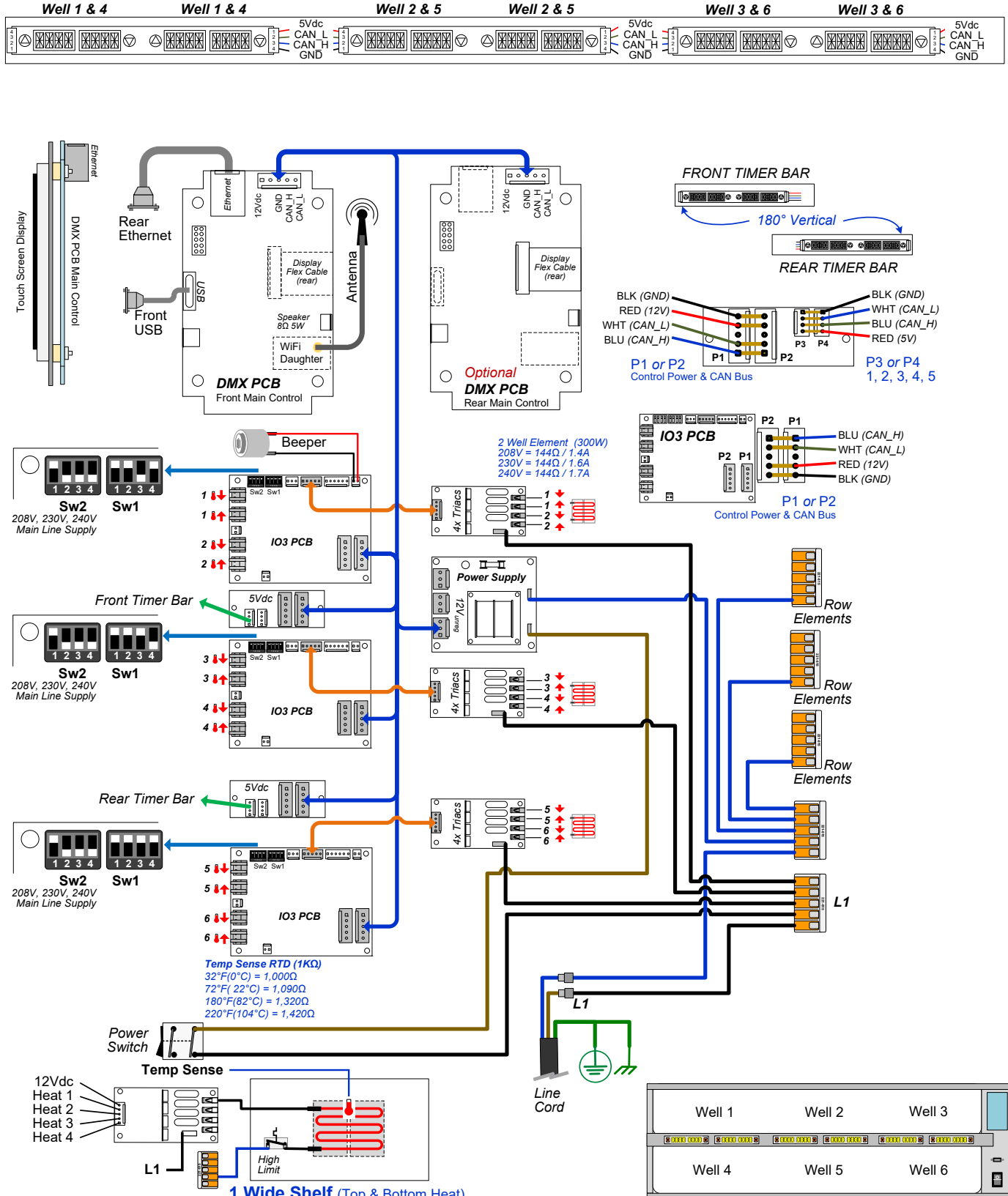

WIRE DIAGRAMS

RFHU-52F Wire Diagram
ELC0788 Rev B

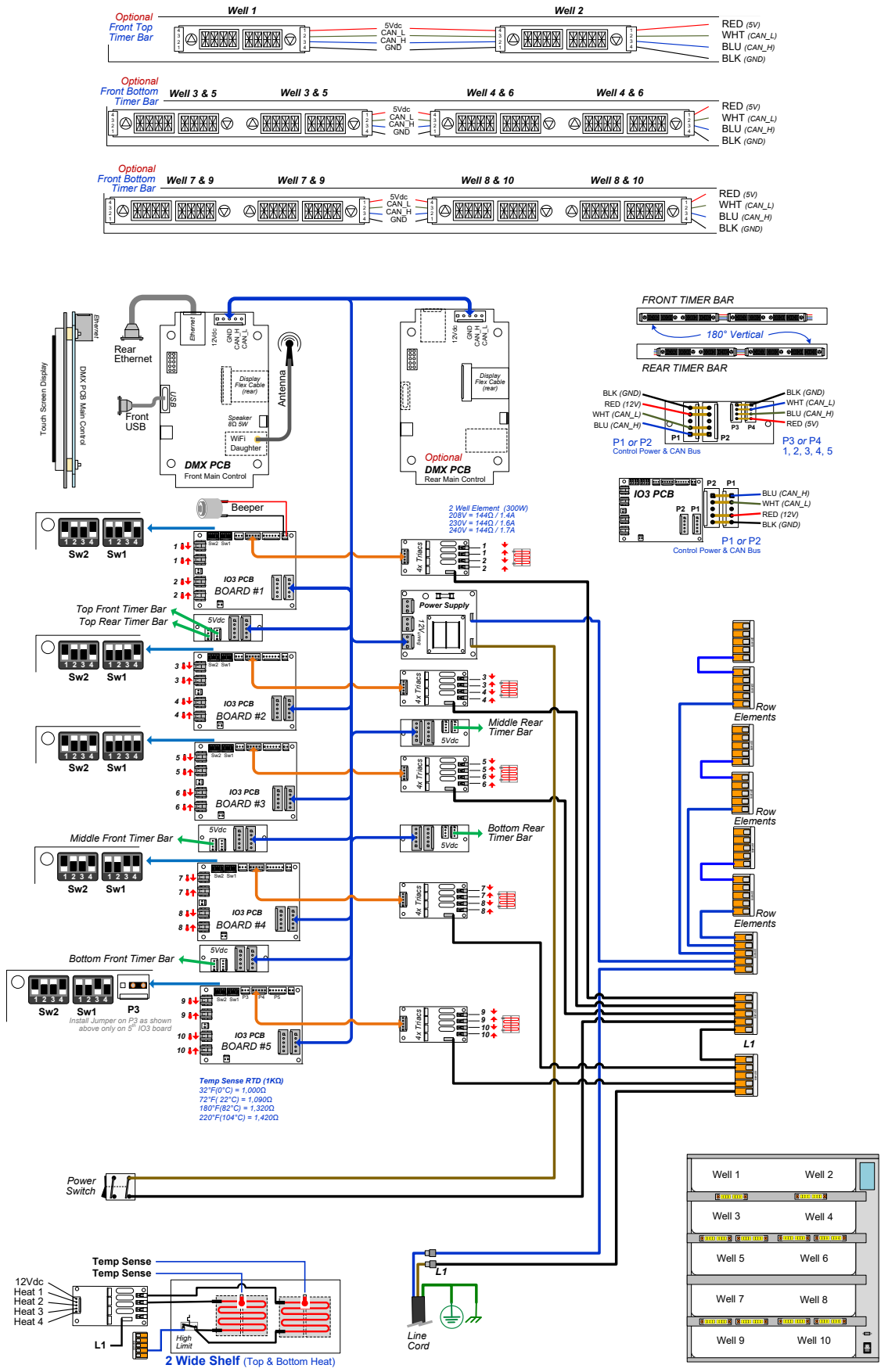

THIS PAGE LEFT BLANK

THIS PAGE LEFT BLANK

THIS PAGE LEFT BLANK



Duke Manufacturing Co.
2305 N. Broadway
St. Louis, MO 63102

Phone: 314-231-1130
Toll Free: 1-800-735-3853
Fax: 314-231-5074

www.dukemfg.com