



Your Solutions Partner

# Installation and Operation Manual

## CASHIER STAND

### MODELS WITH OR WITHOUT CHIP RACK



**CAUTION:** Please read this manual completely before attempting to install, operate or service this equipment

 **WARNING:** Cancer and Reproductive Harm - [www.p65warnings.ca.gov](http://www.p65warnings.ca.gov)

*This manual is Copyright © 2020 Duke Manufacturing Co. All rights reserved.  
Reproduction without written permission is prohibited. Duke is a registered  
trademark of the Duke Manufacturing Co.*

**P/N 529096  
REV B 04/06/2020**



# TABLE OF CONTENTS

**Important Safety Instructions** ..... 2- 4

Inspection and Unpacking ..... 5

Tools Required ..... 5

**Installation**

Cashier Unit - No Extension ..... 6

Cashier Unit/Chip Rack - With End Wall ..... 8

Cashier/Chip Rack - Without End Wall ..... 9

Cashier/Wrap Around Chip Rack..... 10

**Installation Cash Extension**

Cashier Extension before Chip Rack Straight and Wrap around ..... 11

Cashier Extension After Straight Chip Rack..... 12

Installing Front Decor Panels ..... 14

Installing POS..... 15

Installing Safe Surround ..... 16

Installing Other Trim Pieces..... 16

## IMPORTANT SAFETY INSTRUCTIONS

Throughout this manual, you will find the following safety words and symbols that signify important safety issues with regards to operating or maintaining the equipment.



**Indicates a hazardous situation which, if not avoided, could result in death or serious injury.**



**Indicates a hazardous situation which, if not avoided, could result in minor or moderate injury.**



**Indicates Important Information**



**Indicates electrical shock hazard which, if not avoided, could result in death or serious injury and/or equipment damage.**



**Indicates hot surface which, if not avoided, could result in minor or moderate injury.**



**Indicates risk of fire or explosion. Flammable refrigerant used which, if not avoided, could result in death or serious injury.**



**Electrical shock hazard. Do not wash with water jet or hose.**

***In addition to the warnings and cautions in this manual, use the following guidelines for safe operation of the unit.***

- Read all instructions before using equipment.
- For your safety, the equipment is furnished with a properly grounded cord connector. Do not attempt to remove or disconnect the grounded connector.
- Install or locate the equipment only for its intended use as described in this manual.
- Do not use corrosive chemicals on this equipment.
- Do not operate this equipment if it has a damaged cord or plug, if it is not working properly, or if it has been damaged or dropped.
- This equipment should be serviced by qualified personnel only. Contact the nearest Duke authorized service facility for adjustment or repair.
- Do not block or cover any openings on the unit.
- Do not immerse cord or plug in water.
- Keep cord away from heated surfaces.
- Do not allow cord to hang over edge of table or counter.

***The following warnings and cautions appear throughout this manual and should be carefully observed.***

- Turn the unit off, disconnect the power source and allow unit to cool down before performing any service or maintenance on the unit.
- The procedures in this manual may include the use of chemical products. You must read the Material Safety Data Sheets before using any of these products.
- The unit should be grounded according to local electrical codes to prevent the possibility of electrical shock. It requires a grounded receptacle with dedicated electrical lines, protected by fuses or circuit breaker of the proper rating, in accordance with all applicable regulations.
- Disposal of the unit must be in accordance with local environmental codes and/or any other applicable codes.
- This appliance is not intended for use by persons (including children) with reduced physical, sensory or mental capabilities, or lack of experience and knowledge, unless they have been given supervision or instruction concerning use of the appliance by a person responsible for their safety.
- Do not store explosive substances such as aerosol cans with a flammable propellant in this appliance.



**ELECTRICAL SHOCK HAZARD UNIT MUST BE SAFETY GROUNDED, EARTHED.  
DO NOT MODIFY, DEFEAT ELECTRICAL CONNECTIONS OR ALTER PLUG.**

### **ELECTRICAL CONNECTIONS**

**⚠ WARNING** BEFORE CONNECTING THE UNIT TO THE POWER SOURCE, VERIFY THAT THE VOLTAGE AND PHASE OF THE POWER SOURCE ARE IDENTICAL TO THE VOLTAGE AND PHASE INFORMATION ON THE DATA LABEL.

**⚠ WARNING**  
ALL MAINS DISCONNECT MUST BE INCORPORATED IN THE FIXED WIRING IN ACCORDANCE WITH LOCAL WIRING RULES

### **EARTHING INSTRUCTIONS**

1. THE UNIT MUST BE GROUNDED. Grounding reduces risk of electric shock by providing an escape wire for the electric current if an electrical short occurs. This unit is equipped with a cord having a grounding wire with a grounding plug. The plug must be plugged into a receptacle that is properly installed and grounded.
2. Consult a qualified electrician or service agent if grounding instructions are not completely understood, or if doubt exists as to whether the unit is properly grounded.
3. DO NOT USE AN EXTENSION CORD. If the product power cord is too short, have a qualified electrician install a three-slot receptacle (or the country specific receptacle for International Units). This unit should be plugged into a dedicated circuit with the electrical rating as provided on the product data plate.

### **EXTERNAL EQUIPOTENTIAL BONDING TERMINAL (EXPORT ONLY)**

1. This equipment has supplemental bonding terminal. The terminal provides an external bonding connection used in addition to the earthing prong on the plug. The terminal provides a connection for bonding to the equipment enclosure. The external equipotential bonding terminal located on the rear outside surface of the unit, the terminal is marked with the symbol to the right.



### **INSTALLATION CODES AND STANDARDS**

**In the United States**, the Unit must be installed in accordance with the following:

1. State and local codes.
2. National Electrical Code (ANSI/NFPA No. 70, latest edition) available from the National Fire Protection Association, Batterymarch Park, Quincy, MA 02269.
3. Vapor Removal from Cooking Equipment, (NFPA-96, latest edition) available from NFPA.
4. Sealed to the counter upon which the equipment is placed per NSF/ANSI 4 standard.

**In Canada**, the Unit must be installed in accordance with the following:

1. Local codes.
2. Canadian Electrical Code (CSA C22.2 No. 3, latest edition) available from the Canadian Standards Association, 5060 Spectrum Way, Mississauga, Ontario, Canada L4W 5N6.

**“For CE Units**, the Unit must be installed in accordance with the following:

1. Local codes.
2. European (IEC/CENELEC) Electrical Code



# Inspection for Damage and Unpacking

## UNPACKING UNIT

- Inspect the shipping carton and/or container, carefully noting any exterior damage on the delivery receipt
  - Note any damage not evident on the outside of the shipping container (concealed damage). Contact the carrier immediately and file a damage claim with them.
  - Save all packing materials when filing a claim. Freight damage claims are the responsibility of the purchaser and are not covered by the warranty.
  - Report any dents or breakage to source of purchase immediately.
  - **Do not attempt to use unit if damaged.**
  - Remove all materials from unit interior.
  - Remove unit from Skid
  - If unit has been stored in extremely cold area, wait a few hours before connecting power.
1. Remove shrink wrapped bag from the unit. (It is stapled to the crate at both ends.)
  2. Remove strapping and protective cardboard from around the unit.
  3. The feet are set into V-shaped wedges for shipping. Remove all wood pieces from the pallet before trying to lift it off.

**Note:** For 60" units remove two (2) shipping brackets in center front and back of unit.

4. Each unit will come with a kick-plate carton. Unpack the box of kickplates.

**NOTE:** Kick-plate instructions are packed with kickplates.



## Tools and Parts Needed for Installation



Phillips Screw Driver



Adjustable Pliers

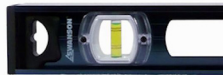

Level



Cordless Drill



Caulk Gun/  
Silicone



Socket set with  
5/16 socket



V-SHAPED WEDGES

# Installation - Cashier Unit - No Extension

## I. Unit Placement and Adjustment

The designation of a LEFT or RIGHT lineup for all Subway Front Counters is determined by the location of the HOT food section. From the Operator's side of the counter, if the HOT food section is on the operator's LEFT, it is a Left-handed lineup. If the HOT food section is on the operator's RIGHT, it is a Right-handed lineup.

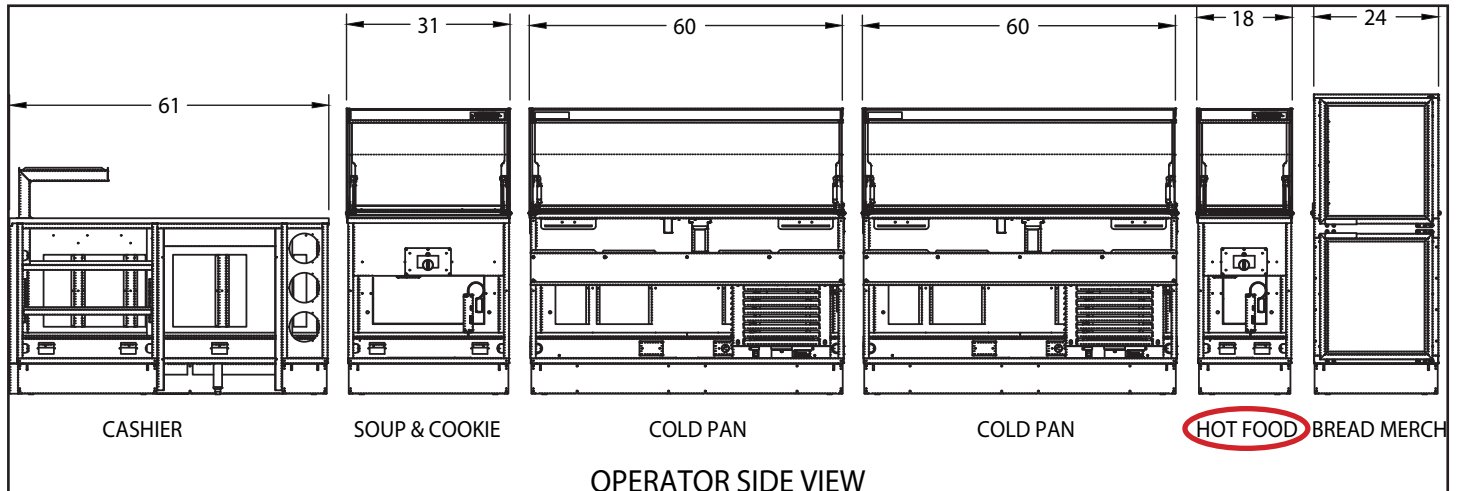

Right Handed Line Up

### Step 1

Line up cashier unit with front counter equipment. Unit to be installed opposite end of hot food unit.



### Step 2

Make sure to level the cashier unit first with other equipment. Adjustment can be made by turning the legs using adjustable pliers.

**NOTE: When installing full line up make sure all units are level with Tri-Channel.**



### CAUTION

Failure to complete this step could result in Decor Panels not lining up.



## Installation - Cashier Unit - No Extension

### Step 3

If a chip rack is being installed remove the grommets from the front side of adjacent counter.



**NOTE:** Skip this step and go to **step 4** if a chip rack is not being installed.



### Step 4

Using four (4) 1/4-20 bolts, attach the cashier unit to the Tri-Channel.

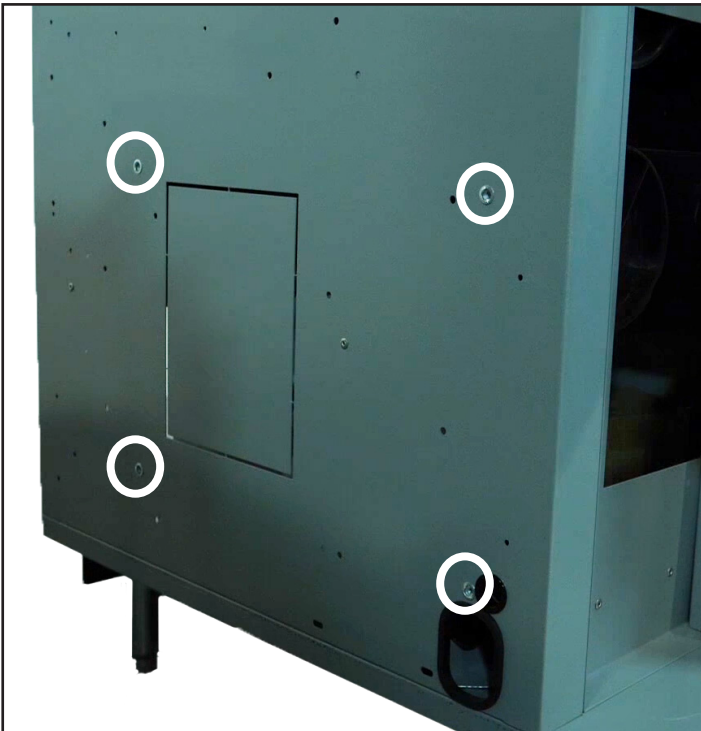

### Step 5

Inside adjacent unit, install the wire chase offset.



### Step 6

Once cash unit is leveled and attached to the tri-channel, install the filler piece to the tri-channel, using four (4) 1-1/2" self tapping screws.



**Go to the next section that applies to your installation**

**Installation - Cashier Unit  
With End Wall Page 8**

**Installation - Cashier Unit  
Without End Wall Page 9**

**Installation - Cashier Unit  
Wrap Around Chip Rack Page 10**

## Installation - Cashier/Chip Rack - With End Wall

### Step 1

Using plastic push pop rivets, install two spacers at end of cashier unit.



Use spacers with notches.

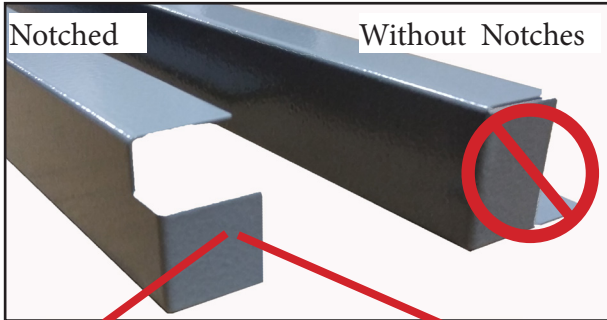

**NOTE:** Top will have a turn down.

### Step 2

Slide Chip Rack into place.

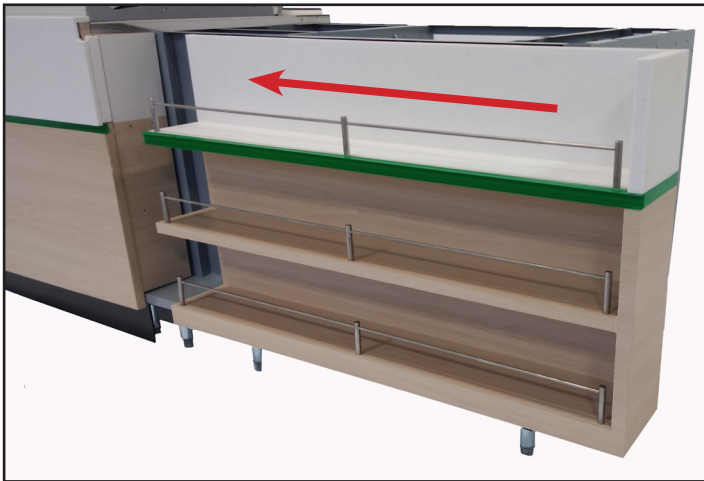

### Step 3

From the operators side, inside the counter, secure Chip Rack using several wood screws.

**CAUTION** Not completing this step could cause damage or bodily injury.



### Step 4

Apply silicone to the top frame and put top in place.



**Note:** Before applying silicone dry fit top to make sure everything lines up.



**Go to page 15 for POS installation**



# Installation - Cashier/Chip Rack - Without End Wall

## Step 1

Slide Chip Rack into place.

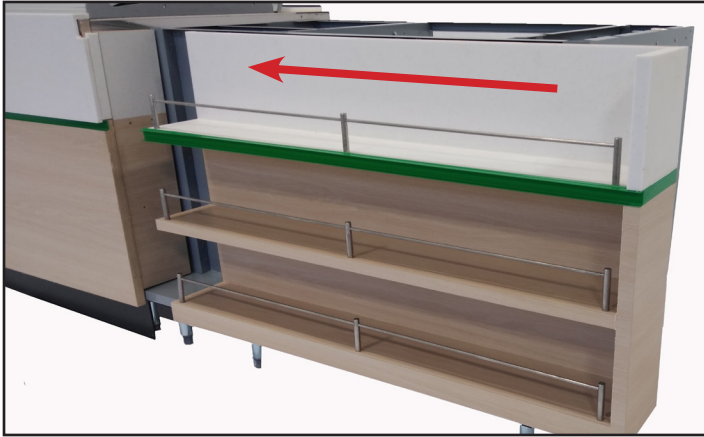

## Step 2

Place end decor panel on end of unit and hold with masking tape to align with front chip rack.



## Step 3

From the inside of the counter secure End Panel using two (2) wood screws.

**CAUTION** Not completing this step could cause damage or bodily injury.



## Step 4

Apply silicone to the top frame and put top in place.



**Note:** Before applying silicone dry fit top to make sure everything lines up.



**Go to page 15 for POS installation**

## Installation - Cashier/Wrap Around Chip Rack

### Step 1

Slide Chip Rack into place and level.



### Step 2

From the operators side inside the counter secure Chip Rack using several wood screws.

**CAUTION** Not completing this step could cause damage or bodily injury.



### Step 3

Apply silicone to the top frame and put top in place.



**Note:** Before applying silicone dry fit top to make sure everything lines up.

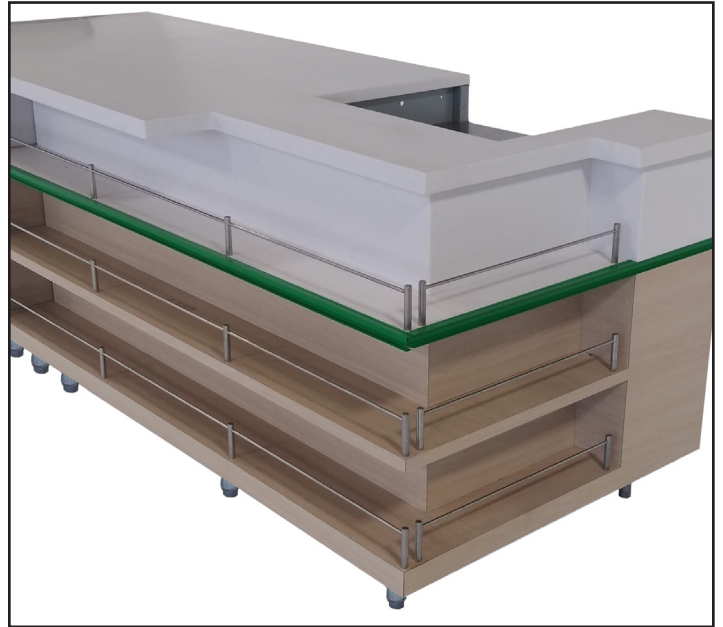

## Installation - Cashier Extension before Chip Rack Straight and Wrap Around Chip Racks

### Step 1



Using plastic push pop rivets install two spacers at end of counter next to tri-channel. Use spacers without notches.

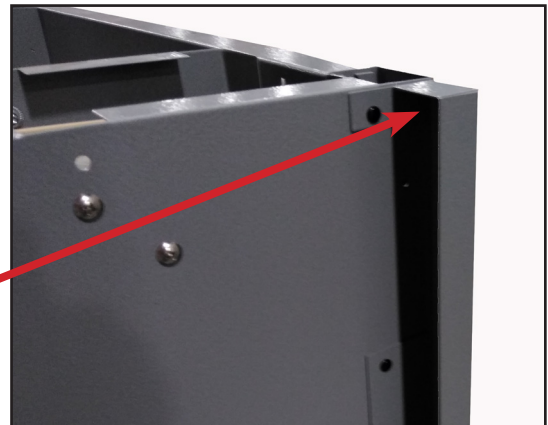
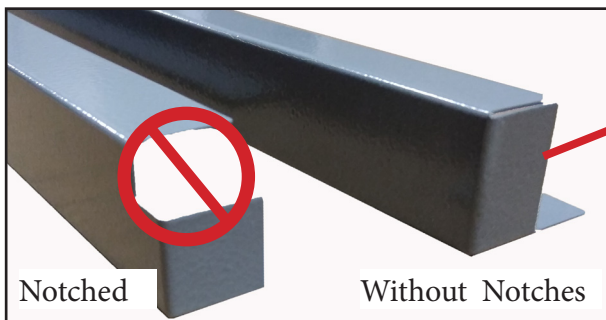

**NOTE:** Top will not have a turn down on wall end.

# Installation - Cashier Extension before Chip Rack Straight and Wrap Around

## Step 2

Align extension unit with Tri-channel and level with Tri-channel unit.

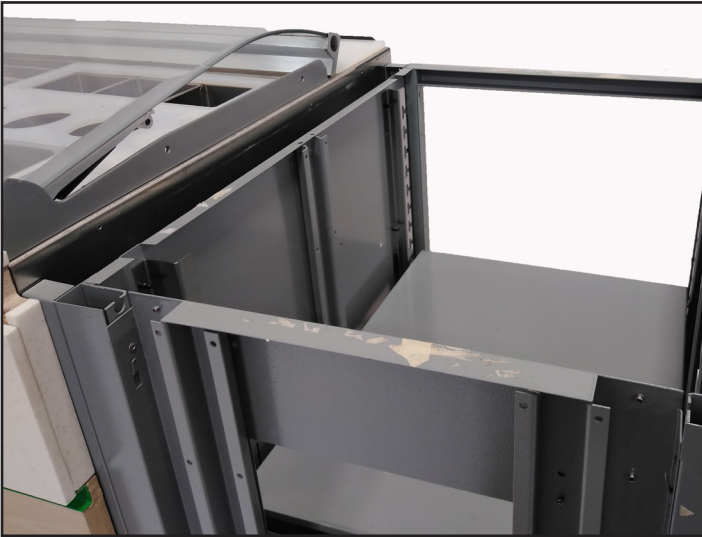

## Step 3

Place Cash unit next to cash extension unit level and secure with four(4) 1/4-20 bolts

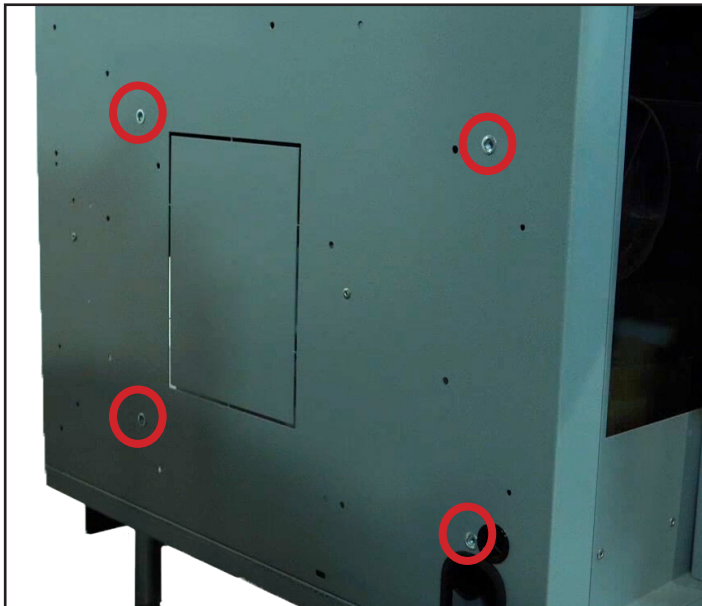

## Step 4

Place front decor panel on front of unit and hold with masking tape to align with front decor panels.

**CAUTION** Not completing this step could cause damage or bodily injury.



See Page 14 for Decor Panel Installation Adjustments

## Step 5

Once extension unit is leveled, install the filler piece to the extension using four (4) 1-1/2" self tapping screws.



**GO TO PAGE 8 FOR INSTALLING STRAIGHT CHIP RACK WITH WALL AT END OF COUNTER**

**GO TO PAGE 9 FOR INSTALLING STRAIGHT CHIP RACK WITHOUT WALL AT END OF COUNTER**

**GO TO PAGE 10 FOR INSTALLING WRAP AROUND CHIP RACK AT END OF COUNTER**



# Installation - Cashier Extension after straight Chip Rack

## Step 1

Complete steps 1-5 on pages 6 and 7.

## Step 2

Using plastic push pop rivets, install two spacers at end of chip rack. Use spacers without notches.

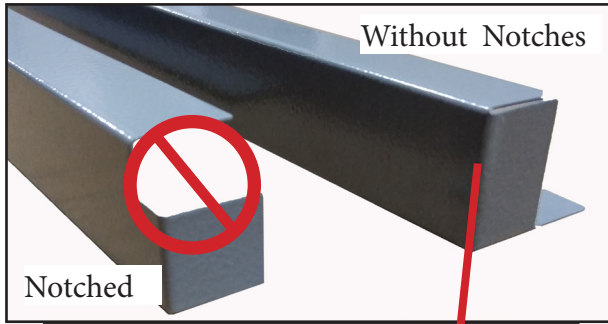

**NOTE: Top will not have a turn down.**

## Step 3

Align extension unit with Chip Rack and level with Chip Rack.



**NOTE: All units should be level with Tri-channel**

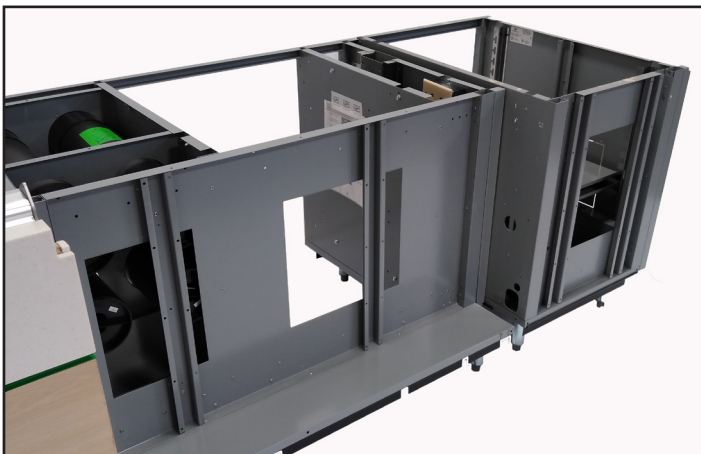

## Step 4

Once extension unit is leveled, place decor panel on front of unit and hold with masking tape to align with front chip rack.

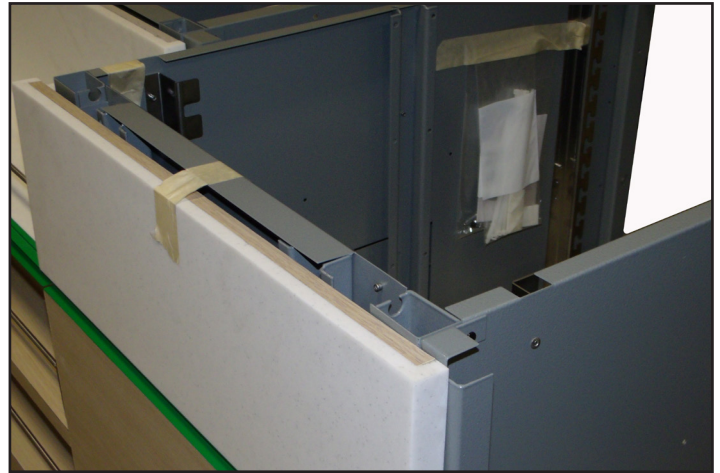

## Step 5

Install the filler piece to the extension unit using four (4) 1-1/2" self tapping screws.



**NOTE: Make sure front edge is flush with frame**



**See Page 14 for Decor Panel Installation Adjustments**

# Installation - Cashier Extension after straight Chip Rack

## Step 6

Slide Chip Rack between two filler panels.

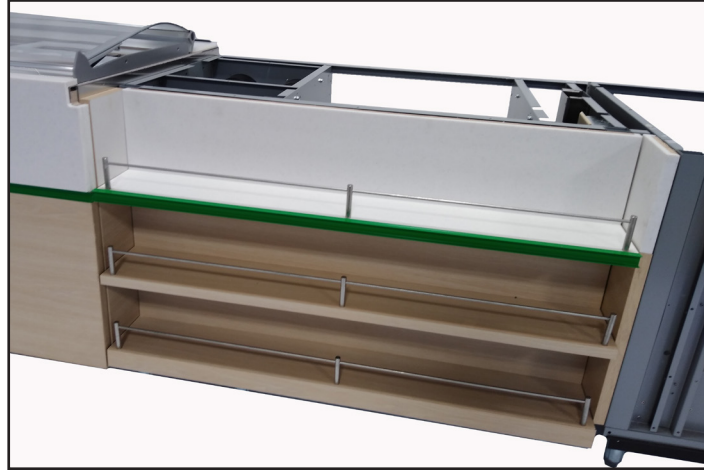

## With End Wall

### Step 7

Using plastic push pop rivets, install two spacers at end of extension rack. Use spacers with notches.

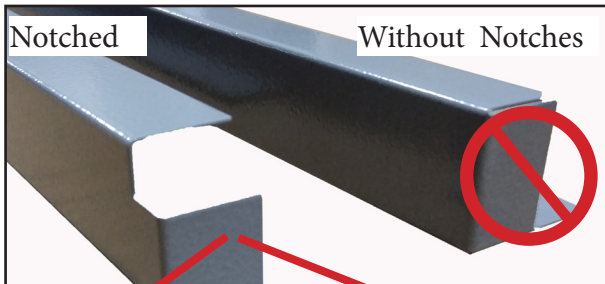

## Without End Wall

### Step 7

Place decor panel on end of unit and hold with masking tape to align with front chip rack.

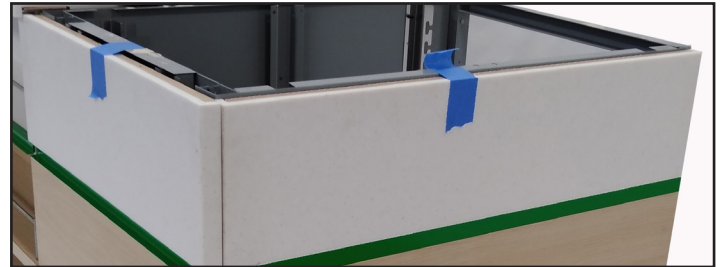

See Page 14 for Decor Panel Installation Adjustments

## Install Tops

### Step 1

Apply silicone to the top frame and put tops in place.



**Note:** Before applying silicone dry fit top to make sure everything lines up.



**NOTE:** Top will have a turn down.



## Installing Front Decor Panels

**Note:** Make sure all electrical is complete before installing front panels

### Step 1 Mounting front panels

#### Step 1

Ensure all brackets on back of panel are adjusted as shown on the right. It is adjusted correctly when you can see the open center (where the bolt is) with the lower flange up above (see Red arrows).



**NOTE:** (3/8" From bottom of bracket to (offset)



**NOTE:** The adjustment bracket allows the decor panel to sit on the kick plate angle when installing the front panel and during adjustment.

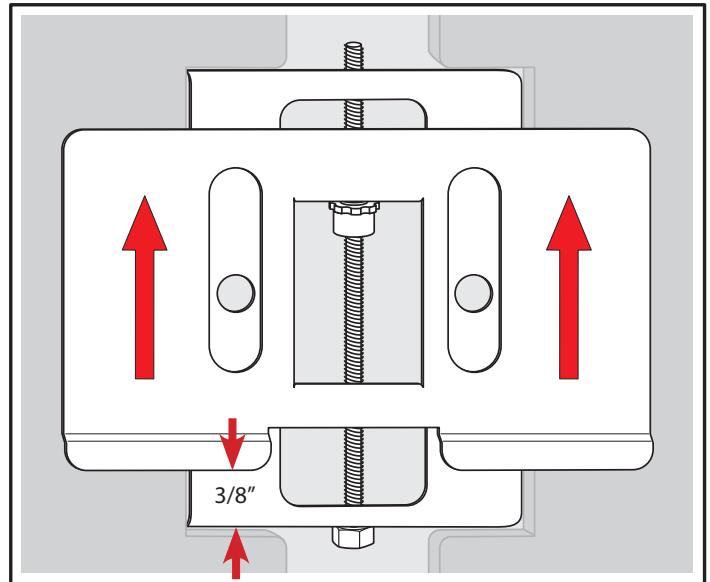

Part Number - ROTJ-ADJ-DECOR-BKT

#### Step 2

Using the brackets, hang the panel on the metal lip at the bottom of the unit. Use masking tape to hold panel in place when there is no channel to hold the panel.



**Pull on bottom of panel to ensure engagement with bracket.**

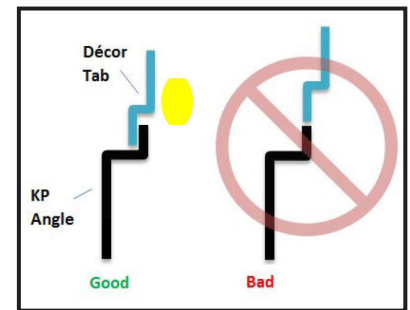

#### Step 3.

Using a 5/16" Socket and ratchet, adjust the panel to be flush against the top.



**Note:** Pictures may be reversed based on type of store.

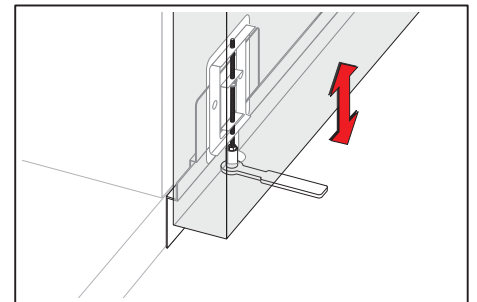

#### Step 4

From inside counter secure all Decor Panels using several wood screws.



**Not completing this step could cause damage or bodily injury.**

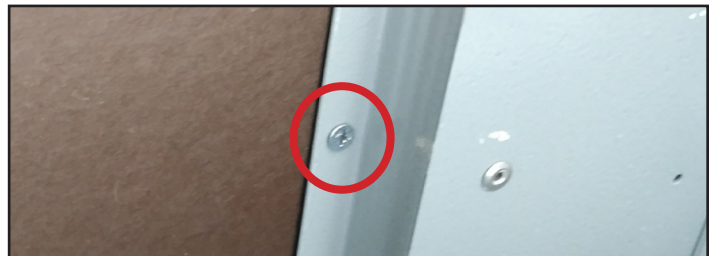

#### Step 5

Repeat steps for all panels.



## Installing P.O.S.

### Step 1

The POS arm ships bolted down to skid or pallet.  
Remove shipping screws and discard.

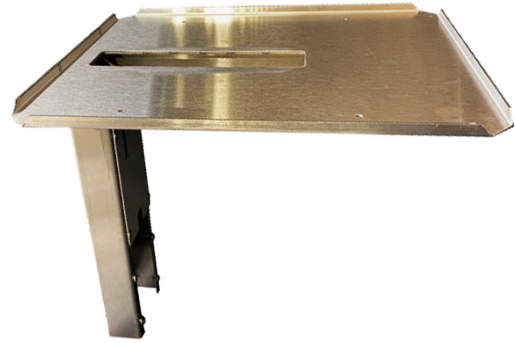

### Step 2

Remove the four(4) mounting screws and save for later.

### Step 3

Slide bezel up on support post and make sure rubber edging is in place for the wire protection.

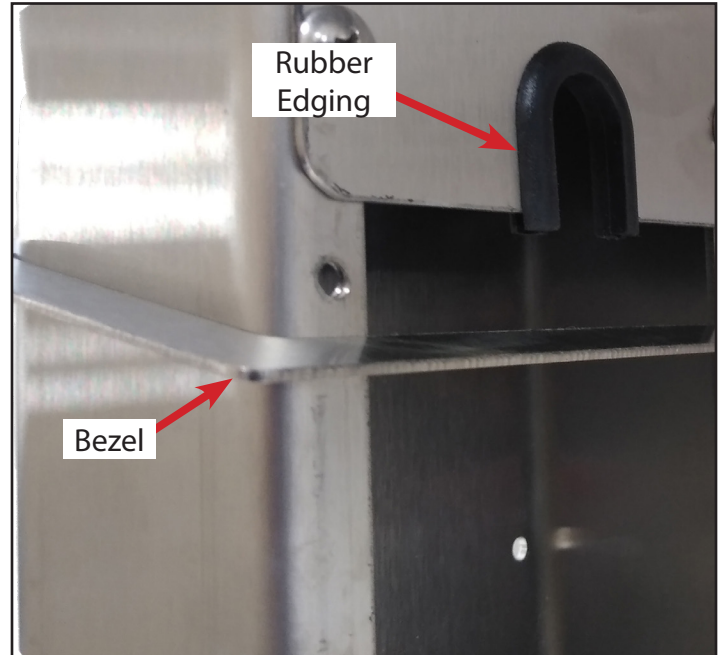

### Step 4

Slide post into opening and secure below with the four mounting screws removed in step 2



## Installing Safe Surround

### Step 1

Locate four (4) 1/4-20 Bolts located under cash unit where safe is to be installed. Remove and save for next step.

### Step 2

Using one bolt for each side install the two side rails for the safe surround at the bottom.



### Step 3

Install the top piece along with the side rails using the other two (2) bolts.



### Step 4

After safe is placed in place, loosen the two side front angles and close opening and re-tighten screws.

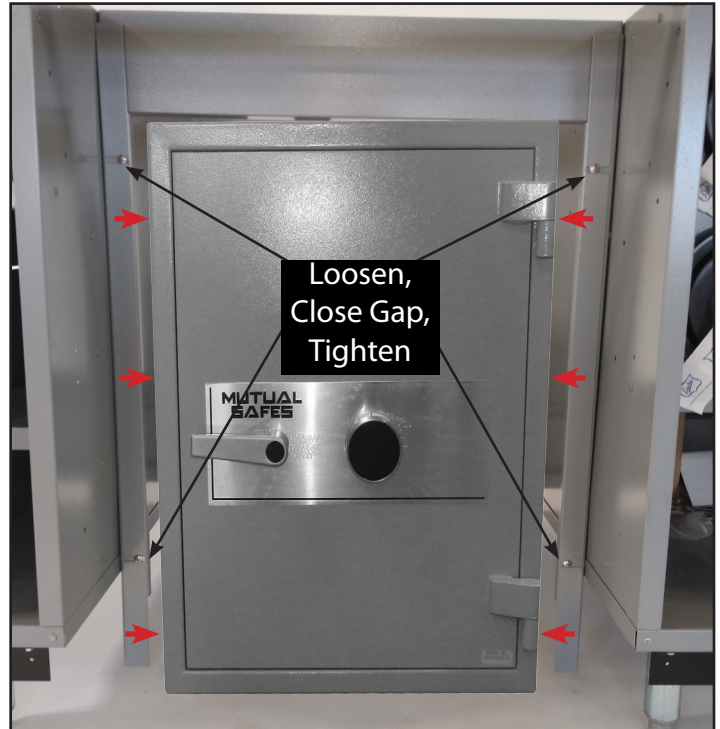

## Other Trim Pieces

### Filler Trim

If a gap exists at end of counter, use double sided tape to attach filler trim piece.



### Filler Trim

Secure mullion trim pieces to cover gaps on operator side between counter sections.



**Duke Manufacturing Co.**

2305 N. Broadway  
St. Louis, MO 63102

Phone: 314-231-1130

Toll Free: 1-800-735-3853

Fax: 314-231-5074

[www.dukemfg.com](http://www.dukemfg.com)